

# GRAFITYP



Sign & Display  
Collection  
2019/20

# Welcome

Why choose our market-leading range of signs and displays?

- Award winning designs for every area of promotional signage and display.
- Low cost, high impact designs for maximum return on investment.
- Developed and used by many leading brands and retailers throughout the UK and worldwide.
- Many unique features and benefits.
- Huge stocks and fast delivery of most popular lines.
- Most products available with no minimum order quantities and no small quantity surcharges.
- Custom colours and sizes available on many lines.
- High quality screen and digital print service available.

## Key

---



In Stock



Made  
To Order



No Tools  
Assembly



Assembly  
Time



Recyclable

# Contents

---

4

Pavement Signs  
& A-Boards

34

Forecourt Signs

50

Cafe & Rope  
Barrier Systems

58

Projecting  
Signs & Flags

76

Snapframes

90

Non-Illuminated  
Displays

106

Illuminated  
Displays

116

Portable Exhibition  
Displays

128

Leaflet &  
Brochure Holders

140

Menu & Information  
Displays

150

Modular Pole  
Displays

158

Chalkboards  
& Accessories

166

Sign Holders

174

Print Services

179

Accessories &  
Spares

KOFFIE

FIND YOUR  
*favourite*



*Cappuccino*



*Americano*



*Latte*



*Espresso*



*Espresso  
Macchiato*



*Espresso  
Con Panna*



*Mocha*

Get to know our perfectly handcrafted  
Italian coffee collection



# Pavement Signs & A-Boards

---

- **Ecoflex 2**

- **Swinger 2**

- **A-Master**

- **Eco Swinger**

- **Booster**

- **Swinger 4000**

- **A-Board**

- **Ecoflextra**

---

We have a wide range of durable **Pavement Signs** and **A-Boards** to suit a multitude of indoor and outdoor promotional uses. Our market leading pavement signs can be seen across exhibition centres, car parks, airports, stations, educational establishments, leisure and hospitality venues.

Many of the products are manufactured in-house and are available in a range of sizes with various panel options, such as printed panel, poster pockets, or **High Pressure Laminate Chalkboard** panels. The **Ecoflex** family features our unique patented wedge, allowing for swift and easy assembly.

## Why is Swinger the UK's market leading sign?

- Beautifully designed and engineered.
- Low centre of gravity for maximum stability.
- Quick and easy 'no tools' assembly.
- Individually boxed and flat packed with instructions.
- Soft round styling for high pedestrian safety.
- Fully recyclable.



← Tactical Header available separately (see page 15)

← Patented 'D-Flex' panel hangers allow for easy 'no tools' panel fitting. Flexibility and low friction ensures panel performance



← Stylish steel frame - can be powder coated in any RAL colour (minimum order quantities apply).

← Choice of aluminium panel or magnetic poster pocket (shown).

← Solid recycled PVC or water fillable HDPE polyethylene base options (recycled PVC base shown).



### 'No Tools' Assembly

- Simply push base onto frame.



### OR

- Lift frame with Swinger 2.



### Top Opening Poster Pockets

Patent No. 2464773 EU Design Registration No. 001274229

- Quick and easy poster change.
- Self closing magnetic seals.
- Virtually no risk of poster loss.
- Provides drain channels to prevent weather damage.



### Built-In Wheels

- Enables safe and easy movement into high visibility positions.
- Fitted on Swinger 3000 and 4000.



### Water Fillable Bases

- Optimum stability.
- Fitted as standard on Swinger 3000 and 4000.

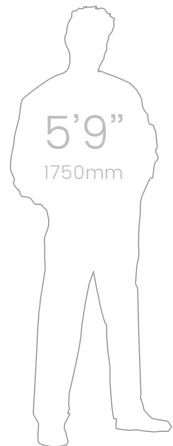

## The Swinger Family

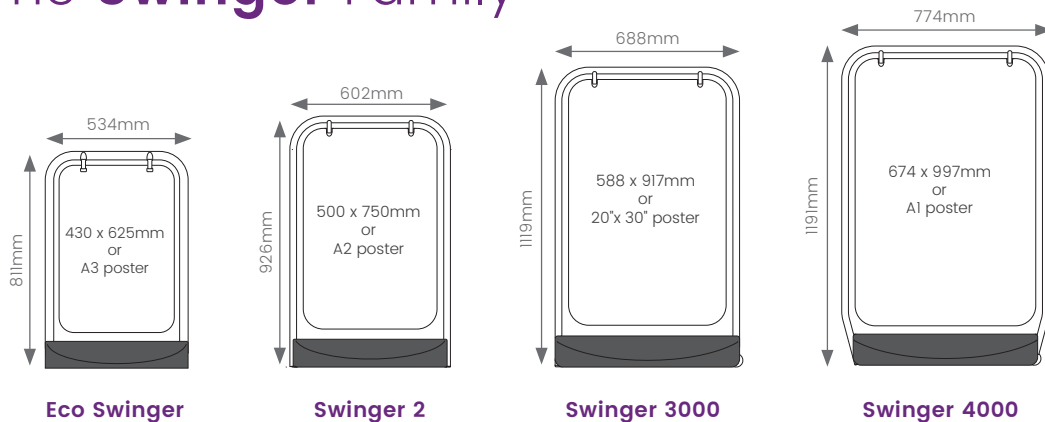

Panel Option	<input checked="" type="checkbox"/>	<input checked="" type="checkbox"/>	<input checked="" type="checkbox"/>	<input checked="" type="checkbox"/>
Poster Option	Made to order	<input checked="" type="checkbox"/>	<input checked="" type="checkbox"/>	<input checked="" type="checkbox"/>

## ECO SWINGER PANEL OPTION

Gloss white aluminium panels ideal for screen/digital printing and vinyl application.



- Gloss white aluminium panel (430 x 625mm) – ideal for screen/digitally printed graphics or vinyl application.
- Stylish 32mm round steel tube frame – available in black or white from stock.
- Frames also available in any RAL colour (minimum order quantity 25).
- Patented 'D-Flex' panel hangers make panel fitting quick and easy.
- Solid black recycled PVC base provides excellent stability.
- Clip-on Tactical Headers also available (see page 15).



'D-Flex' panel hangers make panel fitting quick and easy.



Effortless no tools assembly.

Display Area (mm)	O/A Dimensions (w x h x d mm)	Weight (kg)	Frame Colour	Order Code
430 x 625	534 x 811 x 490	12	White	SWIECOW
			Black	SWIECOB



In stock



1 minute to assemble



No tools assembly



Fully Recyclable



# ECO SWINGER POSTER OPTION

A double sided A3 poster display.



- Top opening polycarbonate poster pocket with magnetic seals.
- Header space provided for either direct print or vinyl graphics.
- Stylish 32mm round steel tube frame – available in black or white from stock.
- Frames also available in any RAL colour (minimum order quantity 25).
- Patented 'D-Flex' panel hangers make panel fitting quick and easy.
- Solid black recycled PVC base provides excellent stability.
- Clip-on Tactical Headers also available (see page 15).



Top opening poster pockets.



Quick and easy no tools assembly.

Poster Size	Display Area (mm)	O/A Dimensions (w x h x d mm)	Weight (kg) Empty/Full	Frame Colour	Order Code
A3	281 X 404	534 X 811 X 490	13	White	SWIECOPOSW
				Black	SWIECOPOSB



In stock



1 minute to assemble



No tools assembly



Fully Recyclable

# SWINGER 2 PANEL OPTION

Patent No. 2549613

Our top selling Swinger model.



- Gloss white aluminium panel (500 x 750mm) – ideal for screen/digitally printed graphics or vinyl application.
- Stylish steel tube frame (32mm diameter) – available in black or white from stock.
- Frames also available in any RAL colour (minimum order quantity 25).
- Patented 'D-Flex' panel hangers make panel fitting quick and easy.
- Solid black recycled PVC base provides excellent stability.
- Clip-on Tactical Headers also available (see page 15).



Tool-free 'out of the box' set up.



Clip-on tactical headers available (page 15).

Display Area (mm)	O/A Dimensions (w x h x d mm)	Weight (kg)	Frame Colour	Order Code
500 x 750	602 x 926 x 525	15.5	White	SWING2ALIW
			Black	SWING2ALIB



In stock



1 minute to assemble



No tools assembly



Fully Recyclable

A panel that can take posters - for tactical promotion.



- Double sided A2 poster display.
- Top opening polycarbonate poster pocket with magnetic seals.
- Poster pockets available in black or white from stock and suitable for screen/digitally printed graphics or vinyl application.
- Stylish steel tube frame (32mm diameter) – available in black or white from stock.
- Frames also available in any RAL colour (minimum order quantity 25).
- Patented 'D-Flex' panel hangers make panel fitting quick and easy.
- Clip-on Tactical Headers also available (see page 15).



Tool free 'out of the box' set up.



Easy access top opening poster holder.

Poster Size	Display Area (mm)	O/A Dimensions (w x h x d mm)	Weight (kg)	Colour (Pocket/Frame)	Order Code
A2	400 x 575	602 x 926 x 525	15.5	White	SWING2PSTW
				Black	SWING2PSTB



In stock



1 minute to assemble



No tools assembly



Fully Recyclable

# SWINGER 3000 PANEL OPTION

The medium sized Swinger option.



- Gloss white aluminium panel (588 x 917mm) – ideal for screen/digitally printed graphics or vinyl application.
- Flat side oval steel tube frame (50 x 25mm) – available in black or white from stock.
- Frames also available in any RAL colour (minimum order quantity 25).
- Patented 'D-Flex' panel hangers make panel fitting quick and easy.
- Black water fillable polyethylene bases for optimum stability. Bases also available in any RAL colour (minimum order quantity 500).
- Built in wheels for ease of movement.
- Clip-on Tactical Headers also available (see page 15).



Optional RAL coloured frames available (minimum order quantity 25).

Display Area (mm)	O/A Dimensions (w x h x d mm)	Weight (kg) Empty/Full	Frame Colour	Order Code
588 x 917	688 x 1119 x 600	12/31	White	H3000BWWA
			Black	H3000BBWA

Base volume 18 litres.



In stock



1 minute to assemble



No tools assembly



Fully Recyclable



# SWINGER 3000 POSTER OPTION

With double sided 20" x 30" poster display.



- Top opening polycarbonate poster pocket with magnetic seals.
- Poster pockets available in black or white from stock and suitable for screen/digitally printed graphics or vinyl application.
- Flat side oval steel tube frame (50 x 25mm) – available in black or white from stock.
- Frames also available in any RAL colour (minimum order quantity 25).
- Patented 'D-Flex' panel hangers make panel fitting quick and easy.
- Black water fillable polyethylene bases for optimum stability, also available in any RAL colour (minimum order quantity 500).
- Built in wheels for ease of movement.
- Clip-on Tactical Headers also available (see page 15).

Poster Size	Display Area (mm)	O/A Dimensions (w x h x d mm)	Weight (kg) Empty/Full	Colour (Pocket/Frame)	Order Code
20" x 30"	488 x 742	688 x 1119 x 600	12 / 31	White	SW3KPSTW
				Black	SW3KPSTB

Base volume 18 litres.



In stock



1 minute to assemble



No tools assembly



Fully Recyclable

# SWINGER 4000 PANEL OPTION

Pack a punch with our largest standard Swinger.



- Gloss white aluminium panel – ideal for screen/ digitally printed graphics or vinyl application.
- Shaped frame enables maximum display area.
- Standard or custom shaped panels available (within 674 x 997mm).
- Stylish oval steel tube frame (50 x 25mm) – available in black or white from stock.
- Frames also available in any RAL colour (minimum order quantity 25).
- Patented 'D-Flex' panel hangers make panel fitting quick and easy.
- Black water fillable polyethylene bases for optimum stability, also available in any RAL colour (minimum order quantity 500).
- Built in wheels for ease of movement.
- Clip-on Tactical Headers also available (see page 15).



Bases available in any RAL colour (minimum order quantity 500).



Option of clip-on tactical header.

Max Panel Size (mm)	O/A Dimensions (w x h x d mm)	Weight (kg) Empty/Full	Frame Colour	Order Code
674 x 997	774 x 1191 x 600	14/32	White	SW4KALIW
			Black	SW4KALIB



In stock



1 minute to assemble



No tools assembly



Fully Recyclable

# SWINGER 4000 POSTER OPTION

The largest standard Swinger option with double sided A1 poster display.



- Double sided A1 poster display.
- Top opening polycarbonate poster pocket with magnetic seals.
- Poster pockets available in black or white from stock and suitable for screen/digitally printed graphics or vinyl application.
- Stylish oval steel tube frame (50 x 25mm) – available in black or white from stock.
- Frames also available in any RAL colour (minimum order quantity 25).
- Patented 'D-Flex' panel hangers make panel fitting quick and easy.
- Black water fillable polyethylene bases for optimum stability, also available in any RAL colour (minimum order quantity 500).
- Built in wheels for ease of movement.
- Clip-on Tactical Headers also available (see page 15).



Easy access top opening poster holder.



Wheels provided for easy positioning.

Poster Size	Display Area (mm)	O/A Dimensions (w x h x d mm)	Weight (kg) Empty/Full	Frame Colour	Order Code
A1	574 x 822	774 x 1191 x 600	14/32	White	SW4KPSTW
				Black	SW4KPSTB



In stock



1 minute to assemble



No tools assembly



Fully Recyclable

# TACTICAL HEADER FOR SWINGER RANGE

Be reactive with our clip on Swinger header.

- Simply clips on to the top of the Eco Swinger, Swinger 2, 3000 and 4000 frames.
- Ideal for short term promotions – additional advertising site for minimal costs.
- 0.9mm rigid gloss white PVC panel for vinyl or screen/digital printed graphics.
- Supplied complete with clips.
- Custom shaped headers available made to order (minimum order quantity 25).
- Poster pocket headers also available made to order (minimum order quantity 50).



Plain units available in quantities of one.



Type	Size (mm)	Order Code
Eco Swinger	480 x 178	THECO
Swinger 2	542 x 197	THSWING2
Swinger 3000	629 x 231	TH3000
Swinger 4000	716 x 230	TH4000



In stock



Fully  
Recyclable



Poster pocket headers



Custom shaped headers



# QUICK REFERENCE GUIDE

Handy Swinger & Ecoflex codes, all in one place.

Swinger - Panel Options					
Product Name	Display Area (mm)	O/A Dimensions (w x h x d mm)	Weight (kg)	Frame Colour	Order Code
Eco Swinger	430 x 625	534 x 811 x 490	12	White	SWIECOW
				Black	SWIECOB
Swinger 2	500 x 750	602 x 926 x 525	15.5	White	SWING2ALIW
				Black	SWING2ALIB
Swinger 3000	588 x 917	688 x 1119 x 600	12/31 (Empty/Full)	White	H3000BWWA
				Black	H3000BBWA
Swinger 4000	674 x 997 (max. panel size)	774 x 1191 x 600	14/32 (Empty/Full)	White	SW4KALIW
				Black	SW4KALIB

Swinger - Poster Options						
Product Name	Poster Size	Display Area (mm)	O/A Dimensions (w x h x d mm)	Weight (kg)	Frame Colour	Order Code
Eco Swinger	A3	281 x 404	534 x 811 x 490	13	Made to order	Made to order
Swinger 2	A2	400 x 575	602 x 926 x 525	15.5	White	SWING2PSTW
					Black	SWING2PSTB
Swinger 3000	20" x 30"	488 x 742	688 x 1119 x 600	12/31 (Empty/Full)	White	SW3KPSTW
					Black	SW3KPSTB
Swinger 4000	A1	574 x 822	774 x 1191 x 600	14/32 (Empty/Full)	White	SW4KPSTW
					Black	SW4KPSTB

Ecoflex (pages 19-24)						
Product Name	Panel Options	Panel Size (mm)	Display Area (mm)	O/A Dimensions (w x h x d mm)	Weight (kg)	Order Code
Ecoflexlite	Aluminium	410 x 795	410 x 763	415 x 805 x 500	7	ECOFLEXLITE
Ecoflex 2	Aluminium	460 x 850	460 x 818	465 x 867 x 540	7.8	ECOFLEX-2
	Chalkboard				8.1	ECOFLEX-2-HPL
Ecoflexextra	Aluminium	540 x 952	540 x 917	545 x 978 x 540	11.3	ECOFLEXTRA
	Chalkboard				11.7	ECOFLEXTRA-HPL
Ecoflex 2 Totem	ACM	460 x 1472 (max. panel size)	460 x 1440 (max.)	465 x 1489 x 540	Panel size dependant	Made to order
Ecoflexextra Totem	ACM	540 x 1450 (max. panel size)	540 x 1415 (max.)	545 x 1477 x 540	Panel size dependant	Made to order

'Eco-nomical' and 'eco-friendly' – ideal for pavement, roadside and forecourt promotions.



- ← Fully recyclable.
- ← Lightweight, portable design.
- ← Gloss white 1.2mm aircraft grade aluminium panel - ideal for screen/digital print or vinyl graphics.
- ← Rounded corners for pedestrian safety.
- ← Maximum visual impact with optimised display area, plus panel shape opportunities.
- ← Option of black HPL chalkboard panels.
- ← Rugged recycled PVC base provides low centre of gravity and high stability.



Unique patented design

Incredibly secure – wedge simply slots through panel and locks into place.



Ecoflex pavement signs tested to Storm Force 10 Beaufort Scale.



## The Ecoflex Family

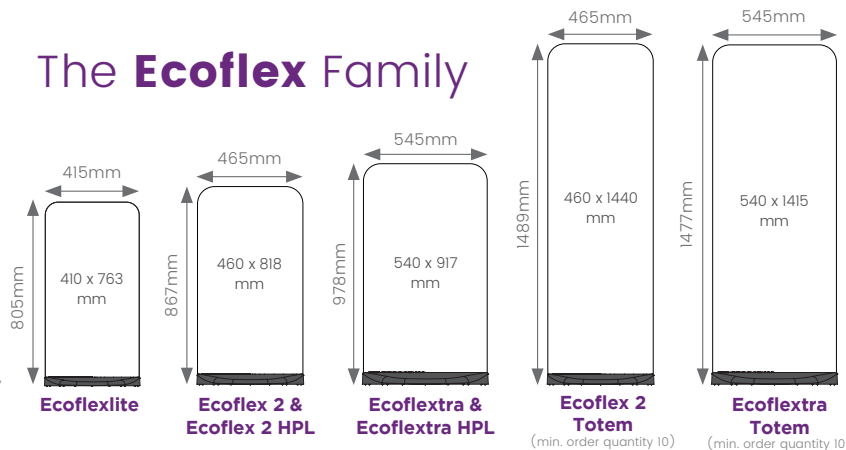

Bases available with embossed logos (min. order quantity 500).

# CUSTOM SHAPED PANELS

Create truly unique and eye catching designs with custom shaped aluminium panels, brought to life with our vibrant screen and digital print.



Made to order  
Minimum order quantity 25

## Chalkboard Panels

3mm HPL (High Pressure Laminate) panel material is a tough writing surface ideal for all chalks and pens.  
Panels available for Ecoflex 2 and Ecoflextra sizes as standard.

Great for personalised messages, changing promotions and special offers.

Options of branded panels using direct print or self adhesive vinyl.

Chalk Pens also available (see page 160).

Note: Chalkboard panels can only be used in bases manufactured to suit a 3mm thick panel.



## Light on price, big on performance.

- Ecoflexlite may be the smallest in our range, but it packs a punch with its 410mm x 763mm display area.
- Aircraft grade 1.2mm aluminium panel is ideal for vinyl graphics, screen or digital printing.
- Unique patented wedge means assembly and disassembly in seconds, with no tools required.
- Recycled PVC base provides great stability.



Shaped panel options also available (minimum order quantity 25).



Panel Size (mm)	Display Area (mm)	O/A Dimensions (w x h x d mm)	Weight (kg)	Order Code
410 x 795	410 x 763	415 x 805 x 500	7	ECOFLEXLITE

**Unique patented design on all Ecoflex options**



- Quick and easy to assemble.
- No tools required!
- Incredibly secure - wedge simply slots through panel and locks into place.



**In stock**



**1 minute to assemble**



**No tools assembly**



**Fully Recyclable**



## The Nation's No.1.

- The top selling individual pavement sign in the UK.
- Medium sized 460mm x 818mm display area.
- Aircraft grade 1.2mm aluminium panel is ideal for vinyl graphics, screen or digital printing.
- Unique patented wedge means assembly and disassembly in seconds, with no tools required.
- Recycled PVC base provides great stability.
- HPL chalkboard option also available.
- Option to have embossed logo in base (minimum order quantity 500).



Shaped panel options also available (minimum order quantity 25).



Panel Options	Panel Size (mm)	Display Area (mm)	O/A Dimensions (w x h x d mm)	Weight (kg)	Order Code
Aluminium	460 x 850	460 x 818	465 x 867 x 540	7.8	ECOFLEX-2
Chalkboard	460 x 850	460 x 818	465 x 867 x 540	8.1	ECOFLEX-2-HPL

**Unique patented design on all Ecoflex options**



- Quick and easy to assemble.
- No tools required!
- Incredibly secure - wedge simply slots through panel and locks into place.



**In stock**



**1 minute to assemble**



**No tools assembly**



**Fully Recyclable**

## Bigger sign, bigger impact - best in class.

- Designed for long range visibility to grab attention.
- Large 540mm x 917mm display area.
- Aircraft grade 1.2mm aluminium panel ideal for vinyl graphics or screen/digital printing.
- Unique patented wedge means assembly and disassembly in seconds, with no tools required.
- Recycled PVC base provides great stability.
- Wind tested for maintenance free use whatever the weather.
- HPL chalkboard also option available.

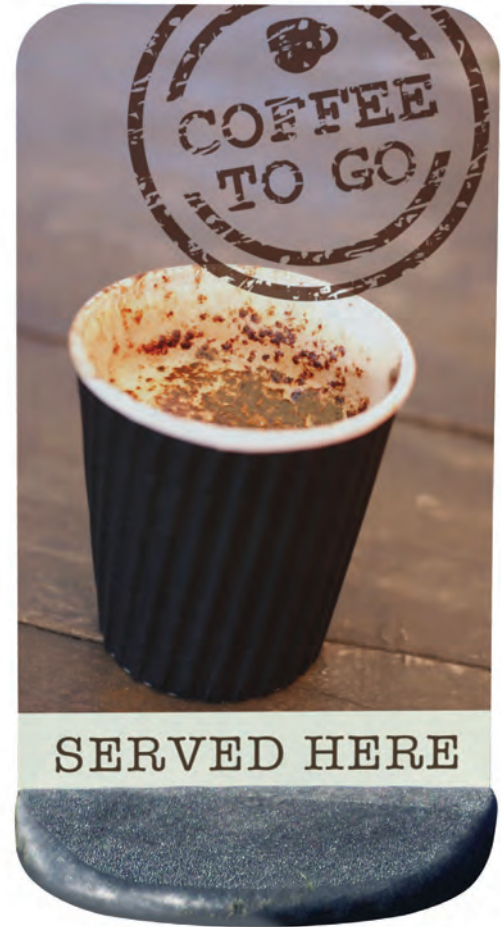
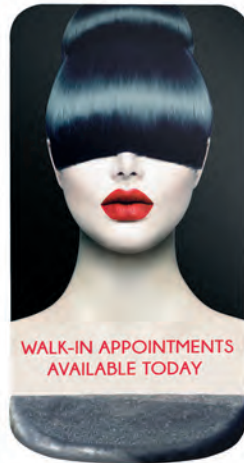

Panel Options	Panel Size (mm)	Display Area (mm)	O/A Dimensions (w x h x d mm)	Weight (kg)	Order Code
Aluminium	540 x 952	540 x 917	545 x 978 x 540	11.3	ECOFLEXTRA
Chalkboard	540 x 952	540 x 917	545 x 978 x 540	11.7	ECOFLEXTRA-HPL



In stock



1 minute to  
assemble



No tools  
assembly



Fully  
Recyclable

## Extra tall panels up to 1.5m for maximum impact.

- 3mm thick aluminium composite (ACM) panels.
- Choose exactly the right size for you, up to 1.5m tall.
- Ideal for vinyl graphics, screen or digital printing.
- Unique patented wedge means assembly and disassembly in seconds, with no tools required.
- Recycled PVC base provides great stability.
- Suitable for indoor or sheltered outdoor use only.
- Totem panels can **only** be used in Ecoflex 2 or Ecoflextra bases which are manufactured to suit a 3mm thick panel.

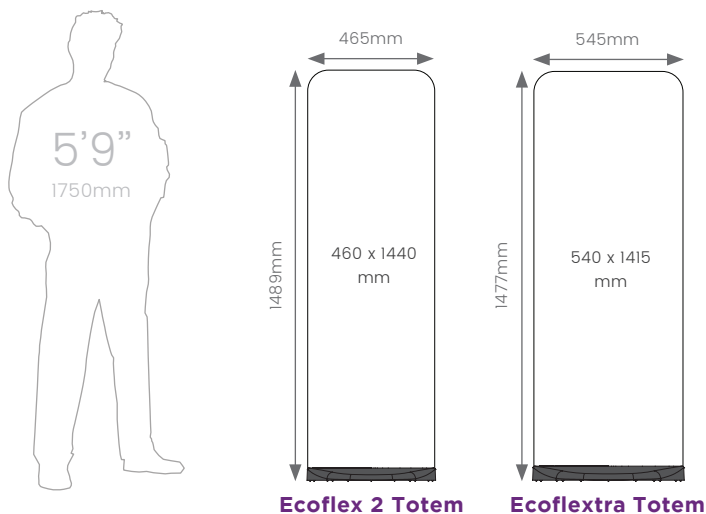

**Made to order**  
Minimum order quantity 10



**1 minute to assemble**



**No tools assembly**



**Fully Recyclable**

# A-BOARDS AT A GLANCE



**A-Board** - page 24

A modern take on the classic shopfront sign - for permanent graphics.



**A-Master** - page 25

The top selling, low priced poster sign in a range of sizes. Frames available in black and silver. Beware lower quality imitations!



**Informer** - page 27

A heavier weight all steel A-Board for 20" x 30" posters with magnetic rubber sealed poster covers.



**Booster** - page 28

A heavier weight all steel A-Board in a range of poster sizes, boosted with a semi circular permanent message header panel.



**Premier Chalk A-Board** - page 29

The steel version of this A-Board is unique in design and leads the market in performance and functionality.



**Chalkstar** - page 30

The affordable all wood chalk A-Board with fixed exterior grade MDF panels. One size only.



**Budget A-Board** - page 31

Lightweight, low cost, gloss white plastic sign for permanent graphics. For sheltered outdoor sites and indoor locations.



**Waterbase A-Board** - page 32

The smallest A-Board for permanent sticker inlay graphic. Ideal for safety message purposes.



**Waterbase Pyramid** - page 32

A 'pillar' design with elevated sticker inlay graphic panel. Connect with chain or rope to form an effective barrier.

# A-BOARD

A completely smooth panel for undisrupted vinyl/print application.

- Double sided 500 x 700mm display area.
- Fixing free aluminium panel surface ideal for vinyl graphic application, screen or digital print.
- Folds flat for easy storage and portability.
- Steel tube rounded frame (32mm diameter), powder coated white as standard.
- Supplied pre-assembled with chrome oval chain, ready for use.

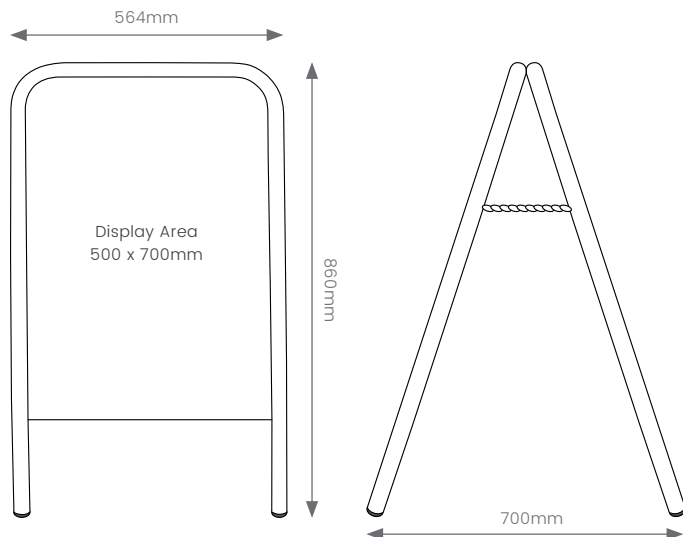

Chrome oval chain maintains optimum leg angle.



Rounded corners for style and safety.



In stock



No tools  
assembly



Fully  
Recyclable

Display Area (mm)	O/A Dimensions (w x h x d mm)	Weight (kg)	Colour	Order Code
500 x 700	564 x 860 x 700	9	White	AB100W2FP



# A-MASTER

The biggest selling A-Board in the market place.

- Double sided poster display in a wide range of sizes.
- Front opening aluminium snapframes with rounded corners for safety (32mm profile).
- Anti-glare poster covers with high UV resistance.
- Add print or vinyl to the back panel for messaging between poster promotions.
- Galvanised steel back panels, hinged locking arms and rubberised feet for optimum weight and stability.
- Available in silver anodised or black powder coated finish from stock.
- Custom sizes and colours available made to order (minimum order quantity 50).
- Fold flat design – easy to move and store.

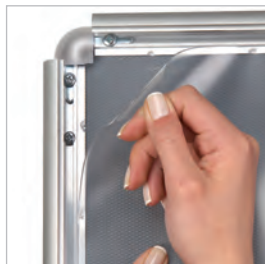

Front opening snapframes for quick and easy poster change.



Rounded corners for safety.



**In stock**  
Certain sizes made to order



**No tools assembly**



**Fully Recyclable**

Poster Size	Display Area (mm)	O/A Dimensions (w x h x d mm)	Leg Length (mm)	Weight (kg)	Availability	Finish	Order Code
A2	400 x 574	463 x 910 x 700	950	6.2	In stock	Silver	ABA2GR(W)
						Black	ABA2BR(W)
500 x 700mm	480 x 680	543 x 910 x 700	950	8.4	Made to order	Silver	AB500GR(M)
20" x 30"	488 x 742	551 x 910 x 700	950	9	In stock	Silver	AB23GR(W)
						Black	AB23BR(W)
A1	574 x 821	637 x 1100 x 800	1150	10.2	In stock	Silver	ABA1GR(W)
						Black	ABA1BR(W)
700 x 1000mm	680 x 980	743 x 1200 x 850	1250	13.4	Made to order	Silver	AB700GR(M)
30" x 40"	742 x 996	805 x 1200 x 850	1250	13.8	Made to order	Silver	AB34GR(M)
A0	821 x 1169	884 x 1400 x 910	1450	16.5	In stock	Silver	ABA0GR(W)

# A-MASTER PLUS

Premium extended A1 poster display, with extra snapframe header.

- Double sided A1 poster display.
- Snapframe header for 594 x 176mm insert.
- Front opening aluminium snapframes with rounded corners for safety (32mm profile, silver anodised finish).
- Galvanised steel back panels, hinged locking arms and rubberised feet for optimum weight and stability.
- Anti-glare PVC poster covers with high UV resilience.
- Custom sizes and colours available made to order (minimum order quantity 50).
- Fold flat design – easy to move and store.
- Recommended for indoor or sheltered outdoor locations.

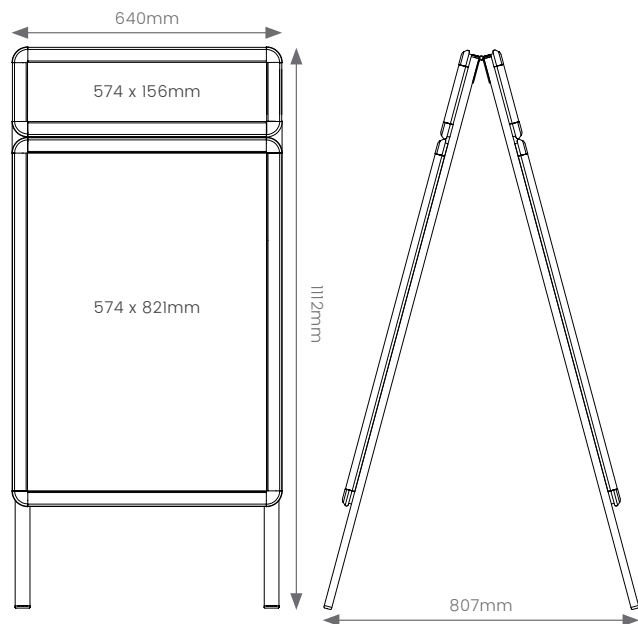

Poster Size	Display Area (w x h mm)	Dimensions (mm)	Weight (kg)	Order Code
A1	Poster: 574 x 821 Header: 574 x 156	O/A: 640 x 1112 x 807 Poster: 594 x 841 Header: 594 x 176	10.6	ABA1PLUS

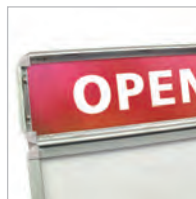

Extra snapframe header.



Anti glare PVC poster covers with UV resilience.



Locking side arms ensure stability.



In stock



No tools  
assembly



Fully  
Recyclable

# INFORMER

## Double sided display with hidden poster change mechanics.

- Double sided 20" x 30" poster display.
- Anti-glare PET poster covers with magnetic seals, excellent poster security and weather resistance.
- All poster covers are complete with colour screen printed borders, providing a longer life span.
- Poster release: simply push poster cover out of frame via hidden release hole in back panel.
- White polyester powder coated steel frame as standard.
- Folds flat for efficient storage.
- 500 micron polypropylene chalk inserts can be supplied for temporary messaging.



Magnetic sealed poster covers.



Hidden poster cover release hole in back panel.



Hinged side locking arm.



Moulded feet for protection and stability.

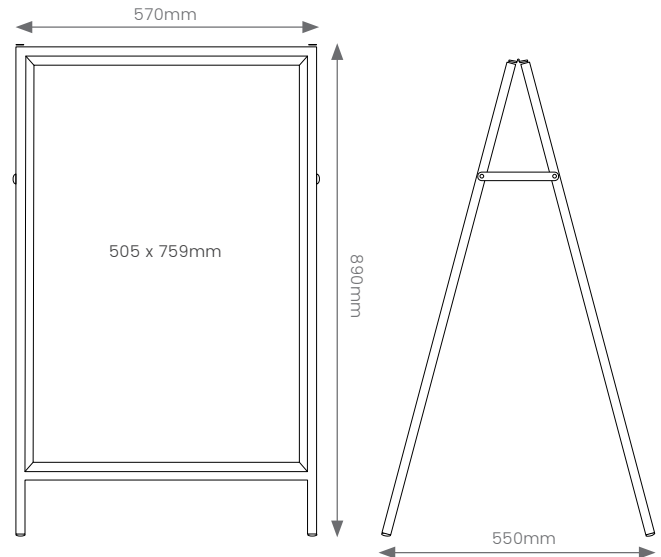

**In stock**



**No tools  
assembly**



**Fully  
Recyclable**

Poster Size	Display Area (mm)	O/A Dimensions (w x h x d mm)	Weight (kg)	Order Code
20" x 30"	505 x 759	570 x 890 x 550	12	IN230W(W)

# BOOSTER

## Attractive poster A-Board with semi-circular header.

- Double sided with additional header area – ideal for vinyl application.
- Anti-glare PET poster covers with magnetic seals, excellent poster security and weather resistance (includes colour matched printed border).
- Poster release: simply push poster cover out of frame via hidden release hole in back panel.
- Steel tube frame (25mm diameter) and steel back panels – available in black or white from stock.
- Also available in a choice of standard RAL colours made to order (any quantity) or custom RAL colour (minimum order quantity 50). Please call our sales team for details.
- Locking side arms and protective feet ensure stability.



Magnetic poster covers – simply push out via hidden release hole.



Locking side arms ensure stability. Also have the option for powdercoat.



**Turn your Booster into a Chalk A-Board with Chalk Insert Panels** (for more information see page 160).

Size	Order Code
A2	INFA2CCB
20" x 30"	INF2030CCB
A1	INFA1CCB



In stock



No tools assembly



Fully Recyclable

Poster Size	Display Area (mm)	O/A Dimensions (w x h x d mm)	Header Area (w x h mm)	Weight (kg)	Colour	Order Code
A2	Poster: 418 x 592 Header: 410 x 230	527 x 1008 x 656	410 x 230	12.8	White	BRA2W(S)
					Black	BRA2BL(S)
20" x 30"	Poster: 506 x 760 Header: 498 x 274	615 x 1237 x 680	498 x 274	17.7	White	BR230W(S)
					Black	BR230BL(S)
A1	Poster: 592 x 839 Header: 590 x 320	701 x 1365 x 747	590 x 320	21.6	White	BRA1W(S)
					Black	BRA1BL(S)

# PREMIER A-BOARD

## Available in 2 sizes and frame styles.

- Reversible panels – up to 4 messages in 1.
- Stylish locking side arms ensure stability.
- Supplied fully assembled and individually boxed with instructions.

### Steel Frames

- Hard wearing rubber hinges allow feet to self level on uneven surfaces.
- 38 x 38mm black powder coated frames, also available in any RAL colour (minimum order quantity 25).
- Choice of three panel materials.

### Wood Frames

- Heavy duty galvanised steel hinges.
- 45 x 45mm softwood frames from renewable sources.
- Dark oak finish with matte varnish protection.
- Only suitable for use with high pressure laminate panels.

### Panel Materials

All suitable for digital print or vinyl application.

#### 3mm Black high pressure laminate

- Suitable for use with traditional chalk or liquid chalk pens.

#### 3mm White aluminium composite material

- Lightweight yet strong premium material
- White face surface

#### 5mm Foam PVC

- Popular sign substrate that is light to handle
- Fine, satin surface finish



### Printed/shaped panels and coloured steel frames available

Shaped panels and coloured frames  
minimum order quantity 25.  
No minimum on printed panels.



In stock



No tools  
assembly

Frame Material	Size (mm)	Panel Material	Display Area	O/A Dimensions (w x h x d mm)	Weight (kg)	Order Code
Metal	Small	3mm High Pressure Laminate	542 x 763	645 x 905 x 670	12	PREMASMM
		3mm Aluminium Composite Material			11	PREMASMMACM
		5mm Foam PVC			10.5	PREMASMMFOAM
	Large	3mm High Pressure Laminate	710 x 1012	810 x 1190 x 690	19	PREMAGLM
		3mm Aluminium Composite Material			16.5	PREMAGLMACM
		5mm Foam PVC			15.5	PREMAGLMFOAM
Wood	Large	3mm High Pressure Laminate	717 x 989	810 x 1145 x 770	17	PREMAGLW

**Please note:** The Wooden Premier Chalk A-Board is made using softwood frames from renewable sources, irregularities and minor marks can occur in the product finish.



Stylish locking arms.



Hard wearing  
rubber hinges.



## A simple, stable and stylish wooden A-Board.

- For a customer that wants a lower cost chalk A-Board solution.
- Double sided 578 x 775mm display area.
- Painted MDF panels suitable for traditional chalk and chalk pens.
- Direct to surface printed panels available to display unique branding (minimum order quantity 25).
- High quality brass screws, hinges and chains for added strength.
- Rubber stand-off feet for grip and stability.
- Traditional wood frame with antique finish and full lacquer for excellent outdoor performance.

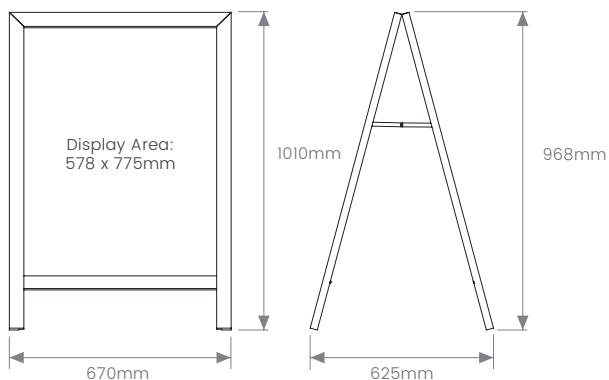

**Direct to surface  
printed panels available**

Minimum order quantity 25

Display Area (mm)	O/A Dimensions (w x h x d mm)	Weight (kg)	Order Code
578 x 775	670 x 968 x 625	7.5	CHLKSTR



Brass screws in top of frame provide added strength.



Traditional wood frame with antique finish and full lacquer for excellent outdoor performance.



High quality brass hinges and chains.



Rubber 'stand off' feet for grip and stability.



**In stock**



**No tools  
assembly**

# BUDGET A-BOARD

## Our most economical A-Board.

- Double sided 480 x 812mm display area for self-adhesive vinyl graphics.
- Made from fully recyclable High Impact Polystyrene (HIPS)
- Comes flat packed, pre-assembled with fixed hinges – simply adjust to the footprint that you require (maximum 680mm for optimum stability).
- Lightweight, folds flat for easy storage and portability.
- Rounded top corners for increased safety and style.
- Suitable for sheltered locations only.
- Chalkboard version available, suitable for use with liquid chalk pens only (see page 159).



Fixed hinge for adjustable open width.



Rounded corners for added style and safety.



Chalkboard option also available.

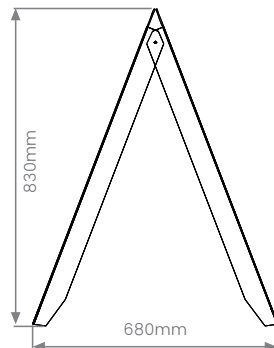
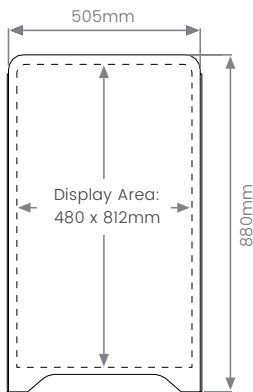

In stock



No tools  
assembly



Fully  
Recyclable

Display Area (mm)	O/A Dimensions (w x h x d mm)	Weight (kg)	Option	Order Code
480 x 812*	505 x 830 x 680	4.3	White	ABPSP
			Chalkboard	ABPCB

\* Recommended to allow 10mm border all round.

# WATERBASE A-BOARD / WATERBASE PYRAMID

## Our smallest A-Board offering.

- Durable polyethylene construction.
- Water fill (6.5 litres) or sand fill for optimum stability.
- Lightweight when empty and folds flat for easy transportation and storage.
- Graphic area 320 x 559mm (sticker inlay required).
- Open to any required width up to 570mm.
- We recommend using high tack vinyl for graphics.
- Also available in custom colours (minimum quantity 500).



Display Area (mm)	O/A Dimensions (w x h x d mm)	Weight (kg) Empty/Full	Order Code
320 x 559*	410 x 754 x 570	3.1/9.6	WBABGREY

\* Recommended to allow 3mm border all round (recess is 326 x 565mm).

## Eye catching display pillar with sticker inlay graphic.

- Durable polyethylene construction.
- Water fill (5.5 litres) or sand fill for optimum stability.
- Simple push fit assembly.
- Graphic area 330 x 385mm with 12.5mm corner radius (sticker inlay required).
- Stands taller than most other pavement signs for eye catching display.
- Supplied flat packed in 3 parts for ease of distribution.
- Recommend using high tack vinyl for graphics.
- Also available in custom colours (minimum quantity 500).



Parts simply push together.



Waterbase pyramid barrier system.



Display Area (mm)	O/A Dimensions (w x h x d mm)	Weight (kg) Empty/Full	Order Code
330 x 385	370 x 1125 x 370	2.2/7.7	WBPSGREY

\* Also available in custom colours (minimum order quantity 500).







**Twister**

**Ornetto**

**Calippo**  
Orange

**WALL'S**

# Forecourt Signs

- 
- **Sightmaster**
  - **Sentinel**
  - **Defender**
  - **Cyclone 2**
  - **POW!**
  - **Bollard Wraps**
  - **Sign Covers**
- 

High impact, durable and repositionable outdoor displays, our market leading forecourt signs are the perfect solution. Our signs are well suited to petrol and dealer forecourts, supermarkets, out of town retail parks, and any store front location where high visibility promotion is required.

For a small budget we have the **Sightmaster 3** poster sign, featuring a water fillable base and snapframe display. Our flagship **Sentinel®** is designed and manufactured for maximum stability and long term performance, as tried, tested and trusted by many of the UK's leading brands and retailers.



## The ultimate forecourt poster sign.

Smooth rounded corners for safety.

Zinc phosphate and polyester powder coated steel frame (50 x 25mm oval).

Silver border and frame as standard. Also available branded or printed with custom coloured frames (minimum order quantity 25).



Clear polycarbonate poster covers offer high impact resistance and UV stability.

Built-in wheels - easy to move with our purpose designed trolley (see page 47 for details).



Magnetic poster covers for quick and easy poster change.



Sentinel Tactical Header available separately (see page 38)

Stainless steel tamper-proof fixings retain poster cover at the top and enable easy poster change by one person (on 30" x 40" and bigger)

Back panel can be printed to ensure brand presence when posters are not in use (minimum order quantity 5)

Magnetic poster covers provide superior weather resistance and poster security.

Water fillable polyethylene base precisely calculated for optimum stability, made using recycled materials.

Black base as standard to hide dirt and marks.



Sentinel® working hard for major retailers across the country.



Lower cost, lighter weight base option available for 30" x 40" and A0 sizes. Volume/contract enquiries only.

External poster signs are a powerful advertising tool. With 70% of purchase decisions made in-store, driving footfall inside is key. Nothing does that better than Sentinel® in a choice of 4 high impact poster sizes.

Available in 4 stock sizes

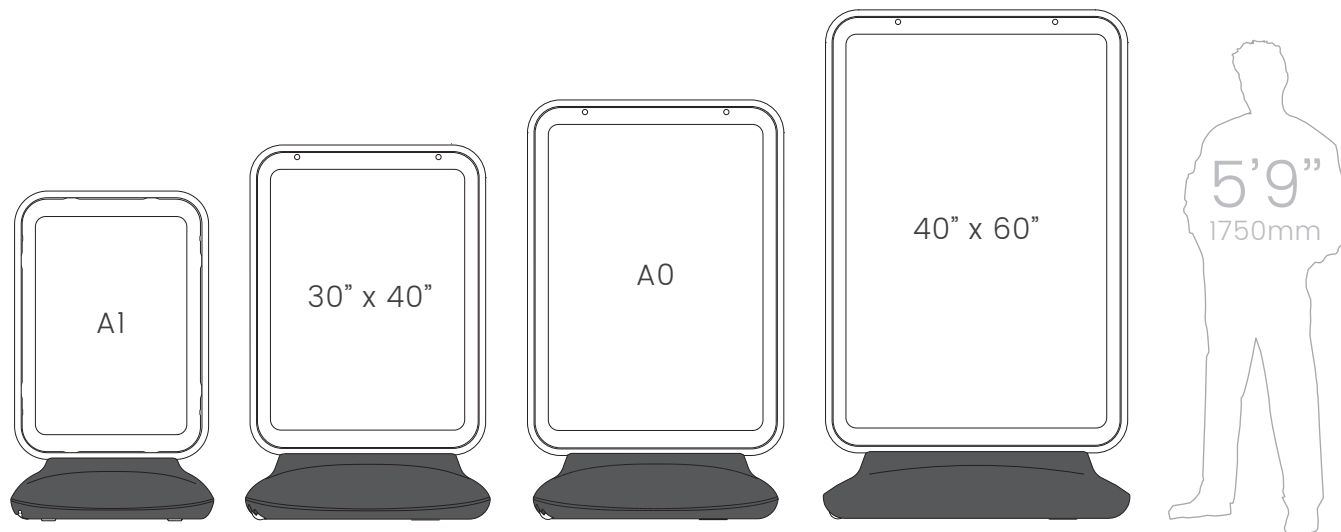

Poster Size	O/A Dimensions (w x h x d mm)	Display Area (mm)	Weight (kg) Empty/Full	Order Code
A1	765 x 1245 x 650	580 x 830	18.5/65	SENA1STD + SENA1BASE
30" x 40"	935 x 1429 x 704	748 x 1004	27/99	SEN34MK4GG + SEN34BASE
A0	979 x 1603 x 704	827 x 1178	31/103	SENA0MK4GG + SEN34BASE
40" x 60"	1171 x 1942 x 894	1002 x 1512	42/150	SEN46MK4GG + SEN46BASE

Also available in custom colours (minimum order quantities apply).



**In stock**



**8 minutes to assemble and fill base**  
Ideally by 2 people



**Recyclable**

Steel frame, polycarbonate poster covers  
and part recycled polythylene base

# SENTINEL® BANNER

Our market leading forecourt sign with printed banner display.

- Steel frame with silver anodised finish as standard – also available in custom colours (minimum order quantity 25).
- Water fillable polyethylene base, precisely calculated for optimum stability, made using recycled materials.
- Black base as standard to hide dirt and marks – also available in custom colours (minimum order quantity 100).
- Built in wheels and purpose designed trolley make it easy to move into position (see page 47 for details).
- Supplied complete with set of elasticated banner ties.
- Digitally printed banners available to order (780gsm reinforced light block PVC as standard).

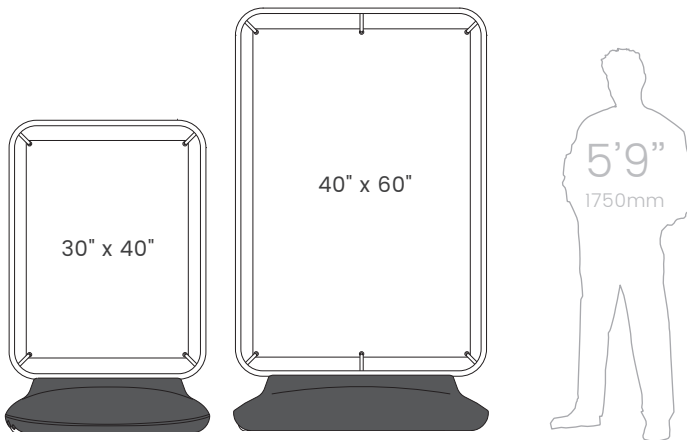

Banner Size	O/A Dimensions (w x h x d mm)	Display Area (mm)	Weight (kg) Empty/Full	Stock Colour Frame/Base	Order Code
30" x 40"	935 x 1429 x 704	742 x 996	25/97	Silver/Black	SENBAN34GG + SEN34BASE
40" x 60"	1171 x 1942 x 894	996 x 1504	38/146		SENBAN46GG + SEN46BASE



Elasticated banner ties supplied.



Built-in wheels for easy transportation.



In stock



**8 minutes to assemble and fill base**  
Ideally by 2 people



**Recyclable**

Steel frame, part recycled polyethylene base and optional reinforced PVC banner

# TACTICAL HEADER FOR SENTINEL®

Be reactive with our clip on Sentinel® header.

- Simply clips onto Sentinel® frames.
- Ideal for short term promotions – additional advertising site at a minimal cost.
- 0.9mm rigid gloss white PVC panel for vinyl or screen/ digital printed graphics.
- Supplied complete with clips.
- Custom shaped headers available, made to order (minimum order quantity 25).



Simply clips on top of Sentinel® and Sentinel® Banner frames.

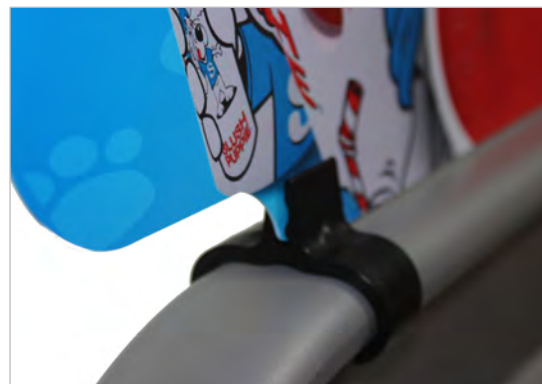

Type	Size (mm)	Order Code
A1	625 x 200	THSENA1
30" x 40"	795 x 215	THSEN34
A0	870 x 230	THSENA0
40" x 60"	1050 x 245	THSEN46



In stock

# SIGHTMASTER 3

Stylish spring mounted snapframe forecourt sign in a range of poster sizes.



The Sightmaster range has proven a popular large format display solution – delivering cost effective tactical promotion in any forecourt position. The Sightmaster 3, available in two colour options with advanced style, stability and performance.

- Front opening aluminium security snapframes for quick and easy poster change. Comes with opening tool and spanner.
- High strength ACM back panel has smooth white fascias for option of self adhesive vinyl graphics, or liquid chalkpen messaging if posters are not in use.
- Unique water fillable HDPE base with built in wheels.
- Heavy duty spring mounts ensure stability by allowing panel deflection in the wind.
- Anti-glare PVC poster covers ensure clarity of message.
- Soft round corners for safety.
- Transit trolley available to aid movement when base is full – 30" x 40" and A0 sizes only.
- Ideal for forecourts, entrance approaches, car parks, retail outlets and shopping centres.



Large base designed for use with our transit trolley (see page 47 for details).



Nylon feet reduce wear and increase stability on uneven surfaces.



Exclusive design base has optimised water capacity for advanced stability.



Improved corner brackets on 30" x 40" and A0 sizes.



**In stock**



**6 minutes to assemble and fill base**



**Fully Recyclable**





Poster Size	Display Area (mm)	O/A Dimensions (w x h x d mm)	Weight (kg) Empty/Full	Colour	Order Code
A1	576 x 821	786 x 1150 x 510	12/48	Silver Frame/Grey Base	SM3A1FRS + SM3SBG
				Black Frame/Black Base	SM3A1FRB + SM3SBB
30" x 40"	744 x 997	956 x 1342 x 609	18.3/81	Silver Frame/Grey Base	SM334FRS + SM3LBG
				Black Frame/Black Base	SM334FRB + SM3LBB
A0	823 x 1173	956 x 1515 x 609	21/83	Silver Frame/Grey Base	SM3A0FRS + SM3LBG
				Black Frame/Black Base	SM3A0FRB + SM3LBB

## Be reactive with our clip on Sightmaster 3 header.

- Simply clips onto Sightmaster 3 frames.
- Ideal for short term promotions – additional advertising at a minimal cost.
- 0.9mm rigid gloss white PVC panel for vinyl or screen/digital printed graphics.
- Supplied complete with clips.
- Custom shaped headers available, made to order (minimum order quantity 25).



Type	Size (mm)	Order Code
A1	582 x 200	THSM3A1
30" x 40"	751 x 215	THSM334
A0	829 x 230	THSM3A0



In stock

# POW! SIGN

Patent No. 2541956

Going above and beyond the standard rectangular poster or banner sleeve, the **POW! Sign** is guaranteed to draw attention.

This innovation in large format signage introduces striking 'breakout' shapes. A new dimension to all leisure, retail and forecourt locations.



**Made to order**  
Minimum order quantity 10



**8 minutes to assemble and fill base**



**Fully Recyclable**



Ideal for breakout shapes and disruptive designs.



Panel slots into place effortlessly.



Cost effective graphic updates in less than 2 minutes.



Purpose designed trolley & hose available separately (see page 47 for details).

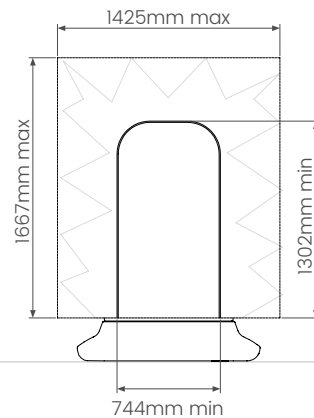
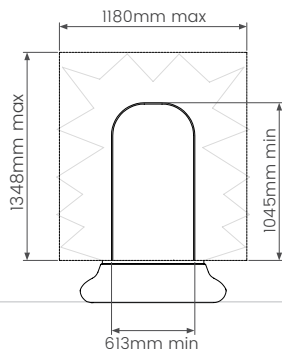
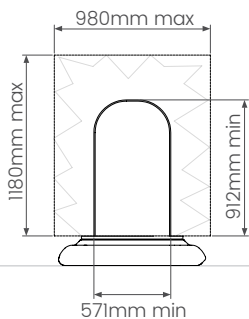

## Base Options

### Waterfill Base



- Black water fillable polyethylene base.
- Built-in wheels for tactical positioning.
- Option to take inside at end of trading.
- Lightweight distribution to site.

### Concrete Base



- For more permanent positioning.
- Lower cost material but generally higher distribution cost.

### Bolt to Ground



- For more permanent graphics bolt frame into concrete floor.
- \* Note: Retailers must have permissions to do so.

# CYCLONE 2 Patent No. 2464696

## Stable and stylish, robust and refined.

- Double sided 40" x 60" poster display.
- Front opening aluminium snapframes for quick and easy poster change.
- White 'Frameworkz' frame as standard – available printed or suitable for vinyl application.
- 700 micron PET poster covers give excellent clarity, fixed along top edge for ease of poster change.
- Steel cradle with hard wearing pivots, allowing panel to move in the wind (black finish only).
- Robust water fillable HDPE base for optimum stability (57 litre capacity).
- Round corners throughout for safety.
- Built in wheels for ease of movement.
- Purpose designed trolley available to assist in moving unit, and hose with tap connector for convenient base filling (see page 47 for more details).



Front opening snapframes for quick and easy poster change.



Frames available printed or suitable for vinyl application.



Hard wearing pivots allow panel to move in the wind.



**In stock**



**8 minutes to assemble and fill base**  
Ideally by 2 people



### Recyclable

Aluminium frames, steel cradle, PET poster covers, polypropylene back panels and part recycled HDPE base

Poster Size	Display Area (w x h mm)	O/A Dimensions (w x h x d mm)	Weight (kg) Empty/Full	Order Code
40" x 60"	980 x 1502	1206 x 1831 x 698	44/101	CYCLONE2 + BASE2

### Cyclone 2's counter-balanced panel deflects wind safely and creates interest through movement:

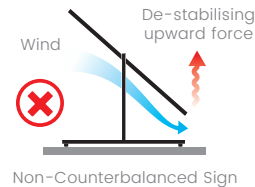
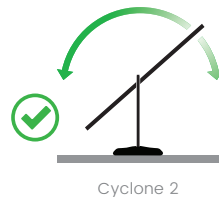
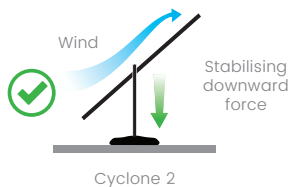

## Permanent large format poster display.

- Front opening 38mm profile aluminium snapframes for quick and easy poster change.
- Anti-glare PET poster covers give excellent clarity.
- Heavy concrete base for optimum stability.
- Steel sub frame with panel area below poster frame suitable for permanent branding.
- Silver anodised snapframe with white steelwork as standard. Custom colours also available made to order (minimum order quantity 25).
- Please call our sales team for delivery charge costs.

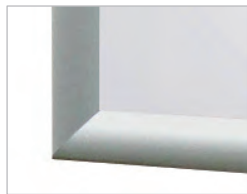
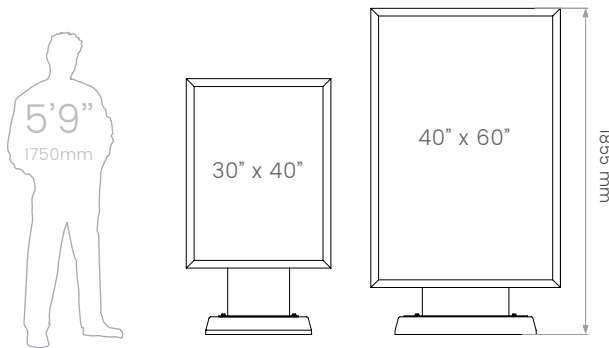

Snapframes for quick and easy poster change.



Anti-glare PET poster covers included.



Steel sub-frame panel suitable for permanent branding.



**In stock**



**Recyclable**

Aluminium snapframes, steel sub-frame and PET poster covers



**8 minutes to assemble**

17mm socket/spanner required

Poster Size	Display Area (w x h mm)	O/A Dimensions (w x h mm)	Base Diameter (mm)	Weight (kg)		Order Code
				Base	Frame	
30" x 40"	729 x 983	818 x 1447	600	53	15	DEF34WA + KIT01
40" x 60"	984 x 1492	1072 x 1855	800	80	24	DEF46WA + KIT02



# SIGN COVERS

Sleeves over a forecourt poster sign for high-visibility promotion and medium-term campaigns.



Promotes new service offers, new products, new site ownership/rebranding and seasonal marketing initiatives. For forecourt, supermarket, retail, service, exhibition and leisure-site locations.

- For medium-term promotions typically 3 to 12 months.
- Borderless printed designs provide up to 38% more display area than the posters they cover.
- Available for popular forecourt sign formats; 30" x 40", A0 and 40" x 60" poster sizes.
- Tear-proof polyester reinforced PVC material and stitched seams for excellent outdoor performance.
- Cover options for rigid frame/fixed-mount signs e.g Sentinel, Defender and spring mounted signs e.g Sightmaster 3
- Tethering holes in lower edge to suit cable-tie or similar for optional added security.
- Custom sizes available.



Made to order



1 minute to assemble



No tools assembly



Existing Sign



Easy-Fit Cover

Sign Type	Poster Size	Cover Dimensions (mm)	Order Code
Fixed-Mount Frame	30" x 40"	960 x 1210	SCFIX34
	A0	1039 x 1373	SCFIXA0
	40" x 60"	1214 x 1707	SCFIX46
Spring-Mounted Frame	30" x 40"	20 x 1092	SCSPRNG34
	A0	1015 x 1278	SCSPRNGA0
	40" x 60"	1170 x 1600	SCSPRNG46

# BOLLARD WRAPS

Transform any bollard into a high impact advertisement.

- Simply pops over existing bollards for effective seasonal marketing or promotion of new products and services.
- Suitable for a wide range of bollard sizes from 100 - 200mm diameter.
- Choose from 3 heights: 800mm, 1000mm and 1200mm
- 3 sided and 4 sided options available.
- Graduated tabs allow quick and easy assembly without the need for any tape, fixings or tools.
- Fine-fluted 3mm Correx polypropylene for resilient outdoor use.



**1 minute to assemble**



**No tools assembly**



**Fully Recyclable**



**Made to order**



# TROLLEY AND HOSE

Convenient assistance for a selection of our large format signs.

- Purpose designed flat pack trolley for easy and safe movement of Sentinel®, Sentinel® Banner, Cyclone 2, large-based Sightmaster 3 and *POW!*.
- 3m hose with tap connector also available for convenient base filling.



In stock



Item	O/A Dimensions (mm)	Weight (kg)	Order Code
Trolley	225 x 1220 x 225	2.5	TROLLEY
Hose	3000 x 13	1	SENHOSE
Adaptor	90 x 45 x 48	0.125	TROLLEYADAPTOR*

\* Only used with old Sightmaster 2 units.

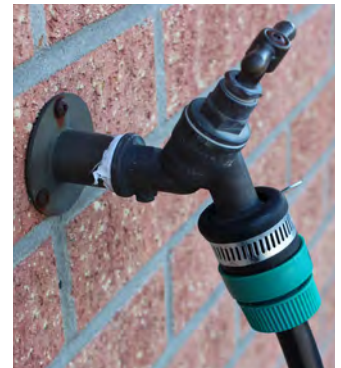

# QUICK REFERENCE GUIDE

Handy Forecourt sign codes, all in one place.

Sentinel - Poster Options				
Poster Size	O/A Dimensions (w x h x d mm)	Display Area (mm)	Weight (kg) Empty/Full	Order Code
A1	765 x 1245 x 650	580 x 830	18.5/65	SENA1STD + SENA1BASE
30" x 40"	935 x 1429 x 704	748 x 1004	27/99	SEN34MK4GG + SEN34BASE
A0	979 x 1603 x 704	827 x 1178	31/103	SENA0MK4GG + SEN34BASE
40" x 60"	1171 x 1942 x 894	1002 x 1512	42/150	SEN46MK4GG + SEN46BASE

Sentinel - Banner Options				
Banner Size	O/A Dimensions (w x h x d mm)	Display Area (mm)	Weight (kg) Empty/Full	Order Code
30" x 40"	935 x 1429 x 704	742 x 996	25/97	SENBAN34GG + SEN34BASE
40" x 60"	1171 x 1942 x 894	996 x 1504	38/146	SENBAN46GG + SEN46BASE

Sightmaster					
Poster Size	O/A Dimensions (w x h x d mm)	Display Area (mm)	Weight (kg) Frame + Base	Colour	Order Code
A1	786 x 1150 x 510	576 x 821	9.8 + 6.0	Silver Frame/Grey Base	SM3A1FRS + SM3SBG
				Black Frame/Black Base	SM3A1FRB + SM3SBB
30" x 40"	956 x 1342 x 609	744 x 997	14.5 + 9.0	Silver Frame/Grey Base	SM334FRS + SM3LBG
				Black Frame/Black Base	SM334FRB + SM3LBB
A0	956 x 1515 x 609	823 x 1173	16.0 + 9.0	Silver Frame/Grey Base	SM3A0FRS + SM3LBG
				Black Frame/Black Base	SM3A0FRB + SM3LBB

Sign Covers			
Sign Type	Poster Size	Cover Dimensions (mm)	Order Code
Fixed-Mount Frame	30 x 40	960 x 1210	SCFIX34
	A0	1039 x 1373	SCFIXA0
	40 x 60	1214 x 1707	SCFIX46
Spring-Mounted Frame	30 x 40	20 x 1092	SCSPRNG34
	A0	1015 x 1278	SCSPRNGA0
	40 x 60	1170 x 1600	SCSPRNG46





SLUG  
TOGETHER & SINCE 1985  
LETTUCE

SLUG  
TOGETHER & SINCE 1985  
LETTUCE



# Cafe & Rope Barrier Systems

---

• **Adfresco Café Barrier**

• **Adfresco LT**

• **Pole & Rope Barrier**

---

**Advertise and manage space simultaneously with these stylish market leading products.**

**We are the only providers of the Adfresco® Café Barrier** hardware. Manufactured to our patented design and quality standards; it combines style and performance at an attractive price.

Banners can be produced to your customer's requirement.

The **Adfresco®** poles and bases can also be used to create an attractive queue management system with either twisted or velvet ropes, available in three colours.

# ADFRESCO® CAFÉ BARRIER

Patent No. 2472843

Stylish, strong and effective – create the perfect space for your customers and brand. Available in Stainless Steel or Satin Black.



Stainless Steel showing lower cross rail and sliding ring tether option.



Satin Black pole

- Unique patented design with market leading features and benefits.
- High quality stainless steel for optimum outdoor life and scratch resistance.
- Tough satin black pole and base for an alternative look.
- 13.5kg x 360mm diameter base provides excellent stability.
- Lower cross rail for full Equality Act compliance or lower cost bungee fixings available.
- Flat packed for easy storage and transport.
- Easy to assemble. Spanner included with base/pole fixing set.
- Stainless steel top cross rail.
- Choice of banner sizes and materials including Light-Block PVC, Mesh PVC and Polyester Canvas.

For greater value – LT Base and Pole.

- Stainless steel.
- Stainless steel top cross rails.
- Low profile concrete filled base. Weight: 10.3kg.
- Supplied with cost effective bottom bungee tether.
- Same choice of banners as Adfresco®.



## Unique features of Adfresco® Café Barrier:

52



### Top/Clip

Sleek top designed for comfortable lifting, comes with quick release cross rails. Supplied with a protective cover to prevent damage in transit.



### Adfresco® Sliding Ring

Unique patented 'smooth glide' ring allows banner to flex and eliminates wind damage associated with traditional designs. Adfresco® only.



### Chrome Plated 'Eye Plate'

An additional mounting chain suitable for cross rails.



### Adfresco® Base

Concrete filled 13.5kg rubber edged base provides optimum stability, prevents damage to floors and gives the option to roll rather than lift.



### Bottom Cross Rail

Optional rigid lower cross rail provides audible 'tap' for visually impaired (Equality Act Compliant). Not available with LT.



### Bungee Connector

Optional lower bungee connector holds banner taut – a cost effective alternative to a bottom cross rail. Prevents over stretching of banner.



In stock



### Recyclable

Stainless steel poles and bases. Designed for easy 'end of life' recycling

# ADFRESCO® CAFÉ BARRIER – SELECTION TOOL

Adfresco® allows you to individually select the elements to create your perfect Café Barrier – all with market leading features and benefits.

## 1

### Choose your poles & bases



#### Stylish and strong stainless steel

Optimum outdoor life and scratch resistance.

OR

#### Classy and cost-effective satin black

A popular alternative to stainless steel.

#### LT Pole & Base

Stainless steel. Only available with lower bungee option.

## 2

### Choose your lower tethering method

#### Double cross-rail option

Provides strength, tautness and Equality Act compliance.

OR

#### Single cross rail and lower bungee option

Select the bungee pole connector and bungees instead of a second cross rail.



Sliding ring

Protective washer to be used with sliding ring



Bungee

Bungee connector

3

### Choose your banner width

For the most exposed locations a shorter banner width performs best: eg. sea front cafe - 1200mm.



4

### Choose your banner material

Choose from a wide selection of printed banners available in a choice of materials – all suitable for outdoor use.

#### Light Block PVC

780gsm



Reinforced and totally opaque, this is perfect for double sided print, long outdoor life and vibrant colour reproduction. The easy wipe clean surface makes it ideal for front of house food and drink environments.

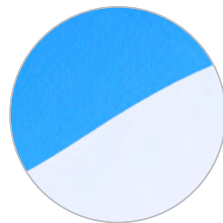

#### Polyester Canvas

450gsm



This close weave 100% polyester fabric has all the appearance, weight and feel of a traditional canvas yet, unlike cotton based canvases, it is cost effective and will not rot or stain. Available full colour printed to one side with the option of white or single colour on the reverse.

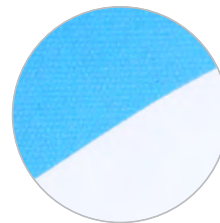

#### Mesh PVC

380gsm



Provides a semi transparent finish and allows some air to pass through making it ideal for windy locations & subtle branding. Full colour print is available on one side (white on reverse).



All of our banners are suitable for outdoor use. To maintain best appearance, occasionally sponge down with warm soapy water. Use ratio: 30ml liquid soap / 10 litres water.



# QUICK REFERENCE GUIDE

Handy Adfresco® and LT codes, all in one place.

Item	Dimensions (mm)	Weight (kg)	Order Code
Stainless Steel Pole and Top Ring	Diameter: 113 (Pole Dia. 51mm) Height: 881	1.0	CBBPOLE-SS
Black Mild Steel Pole and Top Ring	Diameter: 113 (Pole Dia. 51mm) Height: 881	1.5	CBBPOLE-BLK
LT Steel Pole and Top Ring	Diameter: 100 (Pole Dia. 51mm) Height: 881	1.0	CBBPOLE-201
Stainless Steel Base	Diameter: 360 Height: 66	13.5	CBBBASE-SS
Black Base	Diameter: 360 Height: 66	13.5	CBBBASE-BLK
LT Base	Diameter: 360 Height: 45	10.3	CBBBASE-201
Cross Rail (width refers to distance between pole centres)	Width: 1200	0.8	CBBCLIP-2 + CBBCROSSBAR-2
	Width: 1500	1.1	CBBBAR1500-2 + CBBCROSSBAR-2
	Width: 1800	1.2	CBBBAR1800-2 + CBBCROSSBAR-2
Banner	1005 x 838	-	Please call for details
	1305 x 838	-	
	1605 x 838	-	
Adfresco Sliding Ring	Diameter: 110 Height: 30	0.3	CBBRING
Bungee Pole Connector	Diameter: 94 Height: 26	0.1	CBBBUNGCON
Bungee	Overall length: 100	0.01	CBBBUNGEE2
Eye Plate (for wall mounting, not suitable for LT)	40 x 40 x 35 (w x h x d)	0.06	CBBEYERING



# POLE & ROPE BARRIER

Choice of our Adfresco® Poles and Bases or LT Pole and Bases, with a range of rope styles and colours.

- Adfresco® Pole and Base offers the highest quality 3-series stainless steel or satin black poles with high chip/scratch resistance.
- The LT Pole and Base choice offers the lowest cost option.
- Quick and easy to assemble – simple pictorial instructions and spanner included.
- Ropes feature easy 'clip in' attachment – intuitive quick release operation.
- Flat packed for ease of distribution and storage.
- Polished brass finish also available. Minimum order quantity 100. Extended lead times apply.



Item	Colour/Finish	Dimensions (mm)	Weight (kg)	Order Code
Pole and Top Ring	Polished stainless steel	Diameter: 113 (Pole Dia: 51mm) Height: 881	1.0	CBBPOLE-SS
	Black		1.5	CBBPOLE-BLK
	LT	Diameter: 100 (Pole Dia: 51mm) Height: 881	1.0	CBBPOLE-201
Base	Polished stainless steel	Diameter: 360 Height: 66	13.5	CBBBASE-SS
	Black		13.5	CBBBASE-BLK
	LT	Diameter: 360 Height: 45	10.3	CBBBASE-201
Velvet Rope (with foam core and chrome end clips)	Red	Length: 1500 Diameter: 35	0.6	CBBVROPERED
	Black			CBBVROPEBLACK
	Blue			CBBVROPEBLUE
Twisted Rope (cotton/polyester with weighted core and chrome end clips)	Red	Length: 1500 Diameter: 30	0.6	CBBTROPERED
	Black			CBBTROPEBLACK
	Blue			CBBTROPEBLUE
Eye Plate (for wall mounting)	Chrome	40 x 40 x 35 (w x h x d)	0.06	CBBEYERING



Velvet Rope (left) and Twisted Rope (right)  
Available in 3 stock colours.



Ropes feature quick and easy clip in attachment.



Chrome plated 'Eye Plate' available for wall mounting.



In stock



**Recyclable**

Stainless steel poles and bases.  
Designed for easy 'end of life' recycling.

**Please Note:** These ropes are designed for a long, maintenance free life indoors. Outdoor use in sunlight or rain will cause the rope colour to fade and reduce the life of the product.



**Harvester**  
35 Years of fresh thinking

**Harvester**  
35 Years of fresh thinking

**Harvester**  
35 Years of fresh thinking



# Projecting Signs & Flags

- 
- **Flange Signs**
  - **Noscrewz**
  - **Giant Pole**
  - **Standard Flag Kit**
  - **Flying Banners**
  - **Sucker Flags**
- 

A range of free standing, wall and glass mounted projecting signs and flags for retail, events and exhibitions - inside or out.

It includes our high quality **Feather, Teardrop** and **Rectangular Flying Banners** incorporating the finest carbon fibre poles and friction free bearing spindles for optimum outdoor performance.

**Projecting Flange Signs** are available in three standard shapes, we can also make them to custom shapes and sizes. We can also produce displays flags in custom designs for use with our **Standard Flag Kit** and our patented **Noscrewz Flag Kit**.

# FLANGE SIGNS

Low cost, high impact flat projecting signs, available in 3 standard sizes.

- Cost effective, double sided shop front advertising.
- Exceptional value with 5 plus years of outdoor life.
- 2mm aluminium panels with a gloss white polyester powder coated finish – ideal for vinyl application.
- 50mm fixing flange, pre-drilled with round fixing holes as standard.
- Available digitally and screen printed (no minimum order quantity for digital print, screen print minimum order quantity 25).



In stock



Fully Recyclable



Rectangular



Oval



Round

Shape	O/A Dimensions (w x h x d mm)	Display Area (w x h mm)	Weight (kg)	Order Code
Round	556 x 495 x 50	495 diameter	1.8	FLSR
Oval	605 x 400 x 50	500 x 400	1.6	FLSO
Rectangular	582 x 417 x 50	575 x 417	1.8	FLSS



# CUSTOM SHAPED FLANGE SIGNS

Endless possibilities through different shapes and sizes.

- Bring your graphics to life through custom shapes and sizes (minimum order quantity 25).
- 2mm aluminium panels with gloss white polyester powder coated finish.
- Printed using digital and screen print.
- 50mm fixing flange, pre-drilled with round fixing holes.
- Additional plastic mouldings available (minimum order quantity required).
- Option of 3D shaped and moulded signs available for large/nationwide projects (details on enquiring).



**Made to order**  
Minimum order quantity 25



**Fully Recyclable**



# SUCKER FLAGS

## Visible and versatile – inside or out.

- Ideal for chillers, product displays, static vehicles or windows.
- Polyester preprinted flags complete with black reinforced elastic hem.
- Simply secures to smooth surfaces such as glass, plastic or metal.
- Carbon fibre pole keeps flag tight and swivels in the wind.
- Adjustable angle and double sided print for 360 degree effectiveness.
- Quick and easy to change flags for new promotions.
- Kit includes pole bracket and flag.
- Black reinforced elastic hem provides optimum strength.



## Ways to display:



Perfect for chillers and display cases.



Great for forecourts and showrooms.



Also ideal for use on shop frontages.



### Made to order

Minimum order quantity 100



### No tools assembly

Item	Dimensions (mm)	Weight (kg)
Sucker Flag complete unit (flag incl.)	290 x 720	0.15

Easily adjustable angle for any situation



Single lever secures flag and allows quick release

## Ideal for glass mounting.

- Safe, tamper proof and secures on any smooth surface.
- Incredibly quick and easy to use, simply push onto surface and twist. No tools required.
- Kits include bracket, sectional pole, collar and finial.
- Suitable for internal and external use.
- Plain 'Display Flags' held in stock (780gsm reinforced light block PVC), ideal for vinyl application and available printed to order.
- Custom shaped flags also available (minimum order quantity 25).



### How does Noscrewz work?



A simple twist creates a vacuum that locks the bracket in place.



Simply twist back and pull upper or lower tab to release bracket.



**In stock**



**No tools assembly**



**Recyclable**  
PVC/ASA bracket, PVC pole, polypropylene collar and finial, and reinforced PVC flag

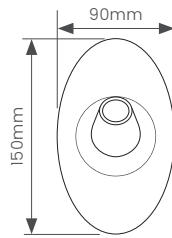

**Bracket**

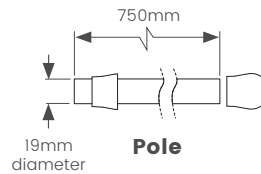

**Pole**

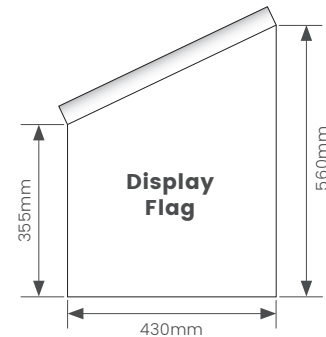

**Display Flag**

\* Care is required if using Noscrewz for oversized (wider and/or taller) flags. Unless the pole is shortened (use of fewer pole sections during assembly) we would only recommend flags in our standard 780gsm reinforced light block PVC up to a maximum of 0.25m<sup>2</sup> (less than 200g in weight).

Item	Dimensions (mm)	Colour	Weight (kg)	Order Code
Noscrewz Flag Kit (bracket, pole, finial and collar)	Bracket: 90 (w) x 150 (h) Pole length: 150/300/450/600/750 Pole diameter: 19	White	0.4	NOSCREWZ2
Display Flag	430 x 355 x 560	White	0.2	FLAGTRADE

# STANDARD FLAG KIT

## For wall mounting.

- Tapered socket ensures excellent pole grip and prevents loss of flags in windy conditions.
- Suitable for screw fixing to walls.
- Kit includes polypropylene bracket, PVC pole, finial and collar.
- Plain 'Display Flags' held in stock (780gsm reinforced light block PVC), ideal for vinyl application and available printed to order.
- Custom shaped flags also available (minimum order quantity 25).
- Marine grade polyester stitching ensures for complete pole/flag security.



PVC pole, collar and finial



Bracket

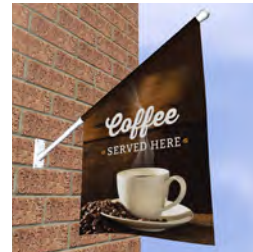
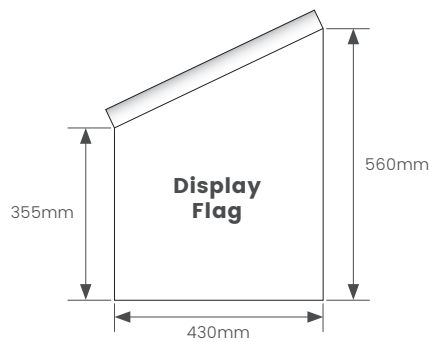

Item	Dimensions (mm)	Weight (kg)	Order Code
Standard Flag Kit (bracket, pole, finial and collar)	Bracket: 50 (w) x 117 (h) Pole: 750 (length) x 19 (dia.)	0.2	FLKIT
Display Flag	430 x 355 x 560	0.2	FLAGTRADE



In stock



Recyclable  
Polypropylene bracket

# QUICK REFERENCE GUIDE

Handy flag codes and diagrams, all in one place.

## Sucker Flag

Item	Dimensions (mm)	Colour	Weight (kg)
Sucker Flag complete unit (flag incl.)	290 x 720	Graphite Black	0.15
Display Flag (printed to order)	290 x 610	White with Print	0.028

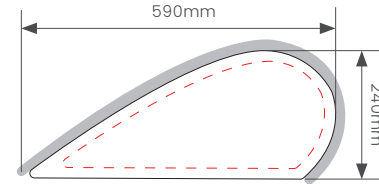

## Standard Flag Kit

Item	Dimensions (mm)	Weight (kg)	Order Code
Standard Flag Kit (bracket, pole, finial and collar)	Bracket: 50 (w) x 117 (h) Pole: 750 (length) x 19 (dia.)	0.2	FLKIT
Display Flag	430 x 355 x 560	0.2	FLAGTRADE

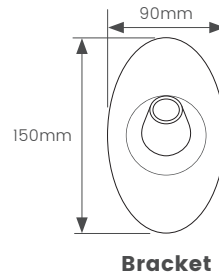
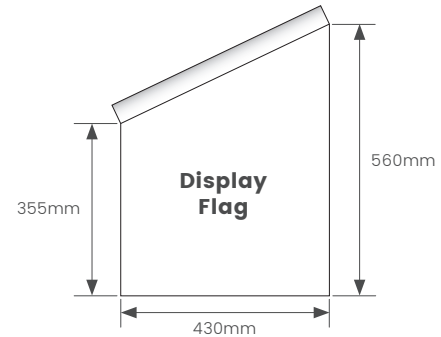

## Noscrewz Flag Kit

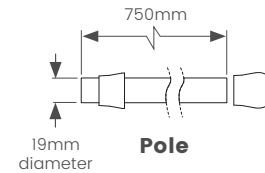

Item	Dimensions (mm)	Colour	Weight (kg)	Order Code
Noscrewz Flag Kit (bracket, pole, finial and collar)	Bracket: 90 (w) x 150 (h) Pole length: 150/300/450/600/750 Pole diameter: 19	White	0.4	NOSCREWZ2
Display Flag	430 x 355 x 560	White	0.2	FLAGTRADE



# FLYING BANNER SELECTION TOOL

## 1

### Shape & Size

Choose between Feather, Teardrop and Rectangular Banners.

All shapes are available in small, medium and large sizes.



Feather  
Page 67



Teardrop  
Page 68



Rectangular  
Page 69

## 2

### Pole Sleeve

Non elasticated wrap around pole sleeves supplied as standard or reinforced black elasticated sleeves are available at a small additional cost.

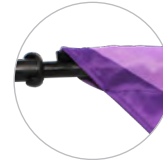

Standard wrap-around  
non-elasticated sleeve.



Black reinforced  
elasticated sleeve.

## 3

### Flag Material

'Close-weave' polyester (115gsm) fabric supplied as standard and 'Airmesh' polyester (135gsm) is available at a small additional cost. Refer to opposite page for more details.

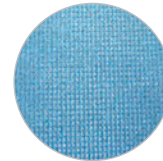

'Close-weave' polyester  
(115gsm)

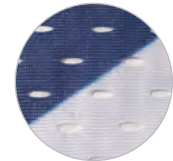

'Airmesh' polyester  
(135gsm)

## 4

### Mounting Accessories

Whether your banner sits on hard or soft ground, indoors or outside, we have a mounting accessory perfect for every occasion.

See pages 73-75 for full details of mounting options.

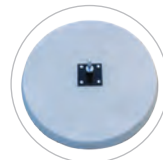

Concrete base

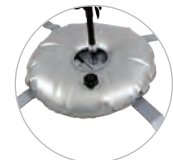

Cross base & water bag



Tank base



Ground spike



Wheel base

## Flag Materials

Our standard flag material is a 115gsm 'close-weave' knitted polyester textile, chosen for its durability and image vibrancy. For optimum performance, a 135gsm 'airmesh' material is also available which, thanks to small holes in the fabric, presents less resistance in the wind.



Standard 'close-weave' polyester flag material (115gsm).

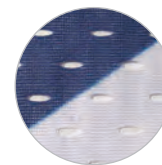

Optional 'airmesh' polyester flag material (135gsm).

## Flag Pole Sleeves

As standard, our flags are supplied with printed, non-elasticated wrap-around pole sleeves, giving maximum possible printed display area. For extra durability, we also offer a reinforced elasticated black sleeve. We recommend this for flags in exposed and unattended locations, such as roadside and 24/7 retail sites.



Printed wrap-around sleeves fitted as standard on all Flying Banner flags.

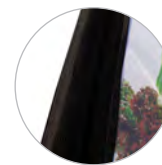

Optional black reinforced elasticated sleeve.

## Dye Sublimation Printing

All Flying Banners are printed by a dye-sublimation process which uses special inks and a post-print heating process to 'fix' the ink into the fabric, making it resilient and washable as well as maximising the mirror image show-through on the reverse.

## Outdoor Performance

Naturally, Flying Banner life span depends on how and where they are used.

Teardrop flags generally last longer than Feather flags as the banner fabric is held in tension and experiences less movement.

Whichever style you choose we recommend taking them in overnight and avoid use in inclement weather (i.e. 24+ mph wind speeds/Beaufort scale 6). Failure to do so will significantly shorten the lifespan of the product.

\* Flag templates available on request, if own flag production preferred.

## Anatomy of our Bearing Spindle

## Engineered for optimum flag life and performance

Our stylish and intelligently engineered steel bearing spindle features in all our Flying Banner mounting accessories (see pages 71-73). It allows friction free flag rotation, so flags can easily align themselves in the wind, minimising banner turbulence for best visibility and reducing strain on the flag to maximise lifespan.

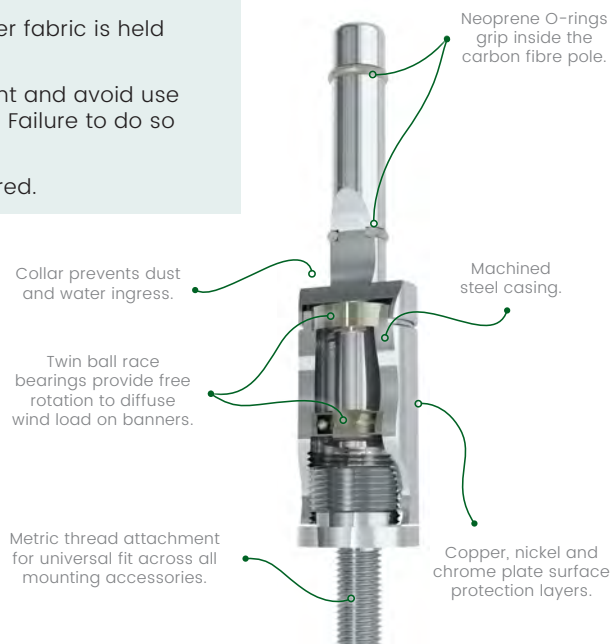

# FEATHER FLYING BANNER

Feather shaped banner which flutters and rotates in the wind.

- High strength sectional carbon fibre pole.
- Market leading detail, quality and performance.
- Printed flags in standard or airmesh polyester textile to order.
- Choice of mounting accessories available.
- Printed, non-elasticated 'wrap-around' pole sleeves giving maximum possible printed display area as standard.
- We recommend an elasticated black pole sleeve for increased durability.

Available in 3 stock sizes

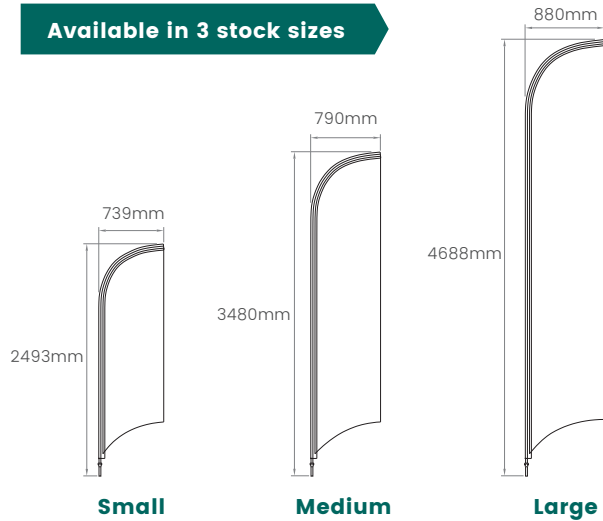

Showing black reinforced elasticated pole sleeve and Base Plate



Black canvas bag supplied with each pole includes compartments to store flag, ground spike and water bag.



Adjustable draw string tethers for optimal tensioning.

Item	O/A Height (mm)	Pole & Bag Weight (kg)	Order Code Pole & Bag	Order Code Printed flags with Wrap around printed pole sleeve	Flag Size Wrap around (mm)	Order Code Printed flags with reinforced elasticated black pole sleeve	Flag Size Elasticated (mm)
Feather Small	2493	1	FBFSM	FBFSMBAN(SW)	698 x 2323	FBFSMBANBEH(SW)	701 x 2246
Feather Medium	3480	1.5	FBFMD	FBFMDBAN(SW)	750 x 3251	FBFMDBANBEH(SW)	753 x 3191
Feather Large	4688	2	FBFLG	FBFLGBAN(SW)	850 x 4421	FBFLGBANBEH(SW)	853 x 4351



In stock



No tools assembly

# TEARDROP FLYING BANNER

## Teardrop shaped banner which rotates in the wind

- High strength sectional carbon fibre pole.
- No fluttering means less distress and increased durability.
- Market leading detail, quality and performance.
- Printed flags in standard or airmesh polyester textile to order.
- Choice of mounting accessories available.
- Printed, non-elasticated wrap-around pole sleeves giving maximum possible printed display area as standard.
- We recommend an elasticated black pole sleeve for increased durability.



Showing black reinforced elasticated pole sleeve and Base Plate

### Available in 3 stock sizes

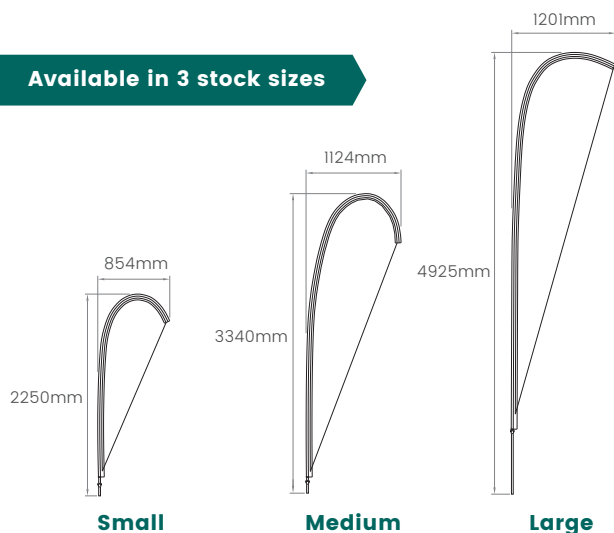

Small

Medium

Large



Black canvas bag supplied with each pole includes compartments to store flag, ground spike and water bag.



Adjustable draw string tethers for optimal tensioning.

Item	O/A Height (mm)	Pole & Bag Weight (kg)	Order Code Pole & Bag	Order Code Printed flags with Wrap-around printed pole sleeve	Flag Size Wrap around (mm)	Order Code Printed flags with reinforced elasticated black pole sleeve	Flag Size Elasticated (mm)
Teardrop Small	2250	1	FBTSM	FBTSMBAN(SW)	771 x 2060	FBTSMBANBEH(SW)	800 x 1992
Teardrop Medium	3340	1.5	FBTMD	FBTMDBAN(SW)	1048 x 3130	FBTMDBANBEH(SW)	1067 x 3062
Teardrop Large	4925	2	FBTLG	FBTLGBAN(SW)	1144 x 4122	FBTLGBANBEH(SW)	1177 x 4052



In stock



No tools assembly

# RECTANGULAR FLYING BANNER

Rectangular shaped banner which flutters and rotates in the wind.

- High strength sectional carbon fibre pole.
- Horizontal top pole ensures branding is always on show, with or without wind.
- Market leading detail, quality and performance.
- Printed flags in standard or airmesh polyester textile to order.
- Choice of mounting accessories available.
- Printed, non-elasticated wrap-around pole sleeves giving maximum possible printed display area as standard.
- We recommend an elasticated black pole sleeve for increased durability.

Available in 3 stock sizes

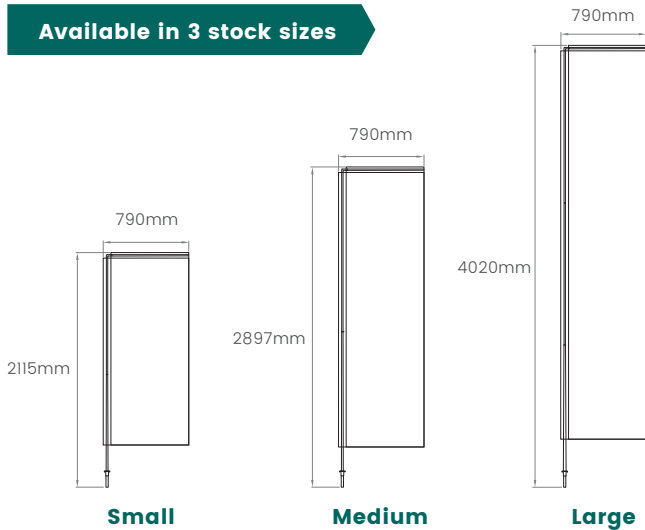

Showing black reinforced elasticated pole sleeve and Base Plate



Black canvas bag supplied with each pole includes compartments to store flag, ground spike and water bag.



Adjustable draw string tethers for optimal tensioning.

Item	O/A Height (mm)	Pole & Bag Weight (kg)	Order Code Pole & Bag	Order Code Printed flags with wrap around printed pole sleeve	Flag Size Wrap around (mm)	Order Code Printed flags with reinforced elasticated black pole sleeve	Flag Size Elasticated (mm)
Rectangular Small	2115	1	FBRSM	FBRSMBAN(SW)	780 x 1770	FBRSMBANBEH(SW)	782 x 1752
Rectangular Medium	2897	1.5	FBRMD	FBRMDBANSW	780 x 2530	FBRMDBANBEH(SW)	782 x 2552
Rectangular Large	4020	2	FBRLG	FBRLGBAN(SW)	780 x 3580	FBRLGBANBEH(SW)	782 x 3602



In stock



No tools assembly



# QUICK REFERENCE GUIDE

Handy Flying Banner codes and diagrams, all in one place.

## Feather Flying Banner

Item	O/A Height (mm)	Pole & Bag Weight (kg)	Order Code Pole & Bag	Order Code Printed flags with Wrap around printed pole sleeve	Flag Size Wrap around (mm)	Order Code Printed flags with reinforced elasticated black pole sleeve	Flag Size Elasticated (mm)
Feather Small	2493	1	FBFSM	FBFSMBAN(SW)	698 x 2323	FBFSMBANBEH(SW)	701 x 2246
Feather Medium	3480	1.5	FBFMD	FBFMDBAN(SW)	750 x 3251	FBFMDBANBEH(SW)	753 x 3191
Feather Large	4688	2	FBFLG	FBFLGBAN(SW)	850 x 4421	FBFLGBANBEH(SW)	853 x 4351

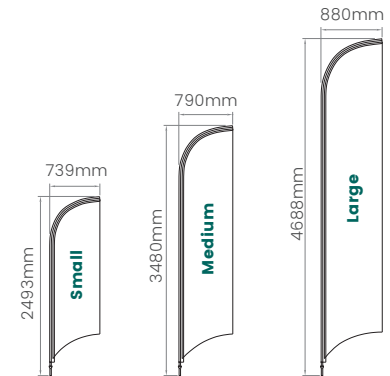

## Teardrop Flying Banner

Item	O/A Height (mm)	Pole & Bag Weight (kg)	Order Code Pole & Bag	Order Code Printed flags with wrap-around printed pole sleeve	Flag Size Wrap around (mm)	Order Code Printed flags with reinforced elasticated black pole sleeve	Flag Size Elasticated (mm)
Teardrop Small	2250	1	FBTSM	FBTSMBAN(SW)	771 x 2060	FBTSMBANBEH(SW)	800 x 1992
Teardrop Medium	3340	1.5	FBTMD	FBTMDBAN(SW)	1048 x 3130	FBTMDBANBEH(SW)	1067 x 3062
Teardrop Large	4925	2	FBTLG	FBTLGBAN(SW)	1144 x 4122	FBTLGBANBEH(SW)	1177 x 4052

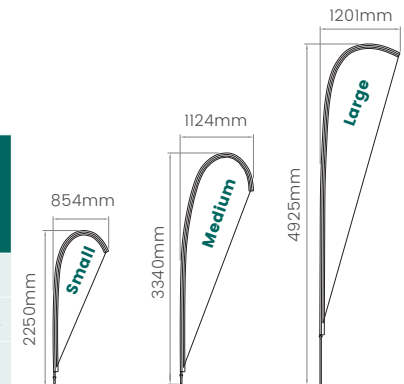

## Rectangular Flying Banner

Item	O/A Height (mm)	Pole & Bag Weight (kg)	Order Code Pole & Bag	Order Code Printed flags with wrap around printed pole sleeve	Flag Size Wrap around (mm)	Order Code Printed flags with reinforced elasticated black pole sleeve	Flag Size Elasticated (mm)
Rectangular Small	2115	1	FBRSM	FBRSMBAN(SW)	780 x 1770	FBRSMBANBEH(SW)	782 x 1752
Rectangular Medium	2897	1.5	FBRMD	FBRMDBAN(SW)	780 x 2530	FBRMDBANBEH(SW)	782 x 2552
Rectangular Large	4020	2	FBRLG	FBRLGBAN(SW)	780 x 3580	FBRLGBANBEH(SW)	782 x 3602

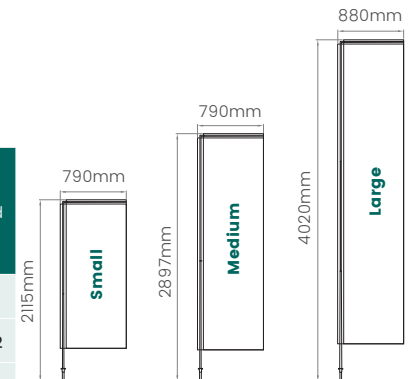

# MOUNTING ACCESSORIES FOR FLYING BANNERS

## Cross Base and Water Bag.

- Stable base for Flying Banners.
- Ideal for use on hard ground, indoors or out.
- Powder coated grey steel cross base, with high quality low friction bearing spindle for smooth flag rotation.
- Holes at end of feet for pegging to soft ground if required (pegs not supplied).
- Optional water bag for added stability.



In stock



**Recyclable**  
Steel cross base and spindle

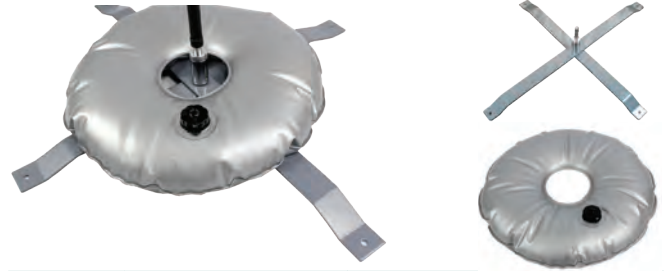

Item	Dimensions (mm)	Weight (kg)	Order Code
Cross Base	Length: 840 Width: 60	4	FBBASE(2)
Water Bag	540 diameter	Empty: 0.4 Full:10.6	FBBAG(H)

## Ground Spike

- Steel spike for soft ground or sand.
- Bearing spindle for smooth flag rotation.
- Male pole connections with 'O' rings provide a perfect and secure fit as well as offering free rotation to deflect wind loading.



In stock



**Recyclable**  
Steel ground spike

Weight (kg)	Order Code
1.2	FBSPIKE(2)

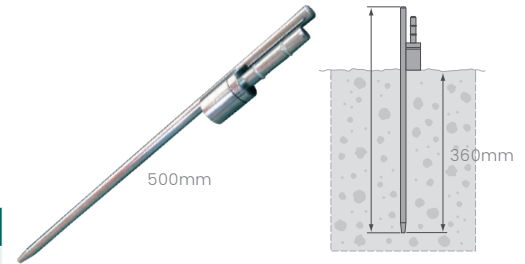

## Wheel Base

- Black powder coated steel feet with chrome plated steel bearing spindle (total weight 4kg).
- Folding design for easy storage.
- 'V' shape allows base to be wedged under any parked vehicle wheel (or driven onto).
- Suitable for all tyre sizes.
- Conversion kit with appropriate poles, gives full height visibility and provides flag clearance away from the vehicle's bodywork (available for small and medium only).



In stock



**Recyclable**  
Steel feet and spindle



Item	Flag and Pole Compatibility	Typical Ground Clearance (m)	Order Code
Wheel Base	All sizes and styles of Flying Banners	–	FBWHEEL(2)
Conversion kit 1	<b>Needs to be ordered with below items</b> Small feather flag + medium pole	1.3	FBCONKIT1
Conversion kit 2	<b>Needs to be ordered with below items</b> Small teardrop flag + medium pole Small rectangular flag + medium Medium feather flag + large pole	1.8 1.3 1.4	FBCONKIT2
Conversion kit 3	<b>Needs to be ordered with below items</b> Medium teardrop flag + large pole Medium rectangular flag + large pole	1.8 1.6	FBCONKIT3

## Concrete Base

- Heavy duty 67kg base solution - ideal for semi-permanent positioning.
- High quality low friction bearing spindle for smooth flag rotation.
- Spindle assembly comes with 4 bolts and spanner (concrete base pre-threaded).
- Lever points provided for ease of movement.

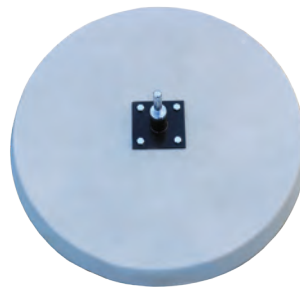

\* Note - due to weight of base, pallet delivery is necessary.

Item	O/A Dimensions (w x h x d mm)	Weight (kg)	Order Code
Concrete base with Bearing Spindle	600 (dia.) x 100 (h)	67	FBCONC + FBCONCBRG
Bearing spindle with Mounting Plate	100 x 132 x 100	0.7	FBCONCBRG



In Stock



3 minutes to assemble

## Tank Base

- A purpose designed water or sand fillable base with our leading low friction bearing spindle for all flag sizes.
- Far superior to alternative 'parasol' base offerings.
- 14 ltr capacity, for water or kiln-dried sand.
- Made from high density polyethylene (HDPE).
- Designed for ease of handling even when full - satisfies manual handling guidelines.
- Stackable design - second tank (part FBSMTK) recommended for large flags outdoors. Provides up to 40kgs of ballast but remains easy and safe to carry in 2 parts.
- Built-in carry handle for ease of movement.
- Screw cap for ease of filling.



Item	O/A Dimensions (w x h x d mm)	Weight (kg)			Order Code
		Empty	Water-filled	Sand-filled	
Tank base + spindle	455 x 110 x 445	2.3	15	20.8	FBSMTK+TKBRG
Tank base only		1.5	14.3	20	FBSMTK
Spindle only	100 x 132 x 100	0.8	-	-	TKBRG



In stock



3 minutes to assemble



Recyclable  
HDPE and steel spindle

## Bracket

- Ideal for parapet walls or concrete forecourts.
- Bearing spindle for smooth flag rotation



Weight (kg)	Order Code
0.7	FBCONCBRG



# MOUNTING ACCESSORIES FOR FLYING BANNERS

## Wall Mount Bearing Spindles (Angled & Vertical)

- High quality, carefully engineered bearing spindle mechanism enables the use of flying banners from a wall situation without having to use floor space.
- Black powder coated gloss finish mount.
- 360 degree rotating spindle mechanism allows banner to move with the wind.
- Fixings are not supplied and appropriate screws should be selected to ensure the bracket is held safely in place.
- Angled Wall Mount Bearing Spindle is angled at 25 degrees and ideally suited at mid to head height to allow clearance of the printed flag from pedestrians.
- Angled Wall Mount Bearing Spindle is suited to small flags only.
- Vertical Wall Mount Bearing Spindle is suited to low walls where the banner can fly freely above the top of the wall.



Item	Weight (kg)	Order Code
Angled	0.83	FB25DGWALBRG
Vertical	0.85	FBVERTWALBRG



In stock



10 minutes to assemble



Fully Recyclable

## Base Plate

- Stylish low profile base solution for interior applications only eg. exhibitions, retail, malls, showrooms, sport and leisure venues.
- Matt black non reflective base finish.
- Integral spigot grip-feature holds pole/flag position and desired 'best line of view'.
- Unobtrusive low-profile height - Base Plate sits just 9mm above floor.
- 3mm thick foam foot pads provide floor protection and ease lifting.
- 2 sizes: Small Base Plate for all small flags and Large Base Plate for all medium and large flags.
- Allen Key tool included to fix spigot to base.



Item	Dimensions (mm)	Weight (kg)	Order Code
Small Base Plate	300 x 300 x 9 (plate 6mm thick)	4.2	FBBASEPLATESM
Large Base Plate	400 x 400 x 9 (plate 6mm thick)	7.3	FBBASEPLATELG



In stock



1 minute to assemble



Recyclable  
Steel Plate

# GIANT POLE

## Huge attention grabbing outdoor display.

- High impact display for 1.1 x 4.1m textile flag.
- Ideal for forecourts, shopping centres, exhibitions and events.
- 2-part water fillable polyethylene base for optimum stability.
- Telescopic aluminium pole with silver anodised finish (54mm diameter at base).
- Printed flags available to order (single and double sided).
- Printed by dye sublimation - see page 176 for more details.
- No tools assembly.

### Double Sided Flags

A twin layer of standard polyester fabric with central liner allows different designs on each side and a good level of opacity. Due to the added weight, double sided flags will not flutter in the wind in the same way as standard flags.



360° rotating flag arm.



Telescopic pole.



2 part base for ease of transportation.

Item	O/A Dimensions (w x h x d mm)	Weight (kg) Empty/ Full	Availability	Order Code
Giant Pole hardware (exc. Flag)	Base: 800 x 180 x 800 O/A height: 5.4m	15/70	In stock	GIANTPOLE(H)
Printed Flag Single Sided	1100 x 4100	-	Made to order	GIANTBANNERS(SW)
Printed Flag Double Sided	1100 x 4100 x2	-	Made to order	GIANTBANNERDS(SW)



**No tools  
assembly**



**In stock**  
Printed flags made to order



**Recyclable**  
Aluminium pole and polyethylene base





WHSmith

CELEBRATING

225

YEARS

EST · 1792

EDUCATIONAL COLOURS

JUMBO

# Snapframes

- 
- **Frameworkz**
  - **Security**
  - **Lockable**
  - **Counterstand**
  - **Cable Suspended**
  - **Minimus**
- 

We have one of the largest ranges and stocks of snapframes in Europe. We are very competitive, however our price is not at the expense of quality.

When you are thinking of buying a snapframe from elsewhere, particularly for outdoor use, ask the supplier if the poster cover sheets are UV stable. In other words, can they guarantee that the cover sheet will not tarnish within 6 months due to sunlight? We can! It is important for the customer whose main interest after all is an optically clear view of their poster message and branding.

We manufacture a wide variety of non-standard sizes and quantities, with no minimum order quantity. Fourteen stock finishes support our **express made to order service**, which commits to turnaround small quantity orders within 3-5 days.

We also provide a **custom manufacture service**, which offers a further 74 RAL colours and over 20 BS 4800 colours. This service is offered in a range of frame profiles with the standard, security and lockable styles. Minimum order quantities may apply in some cases.



# SNAPFRAMES



Low prices



Large stocks



Fast delivery



Wide range  
of styles

## All our Snapframes feature:

- Quick and easy poster change.
- When closed, all fixings and opening methods are hidden from view.
- Silver anodised finish as standard (unless otherwise stated).
- Anti-glare poster cover sheets.
- Pre-drilled and individually boxed with screws and wall plugs.
- White or grey plastic back panels depending on size/style.
- Suitable for indoor or outdoor use. Note - poster cover sheets are not fixed and in high winds can become dislodged, wider frame profiles provide better poster security.



For added security, see our **Security** (P. 84) and **Lockable Snapframes** (P.85).

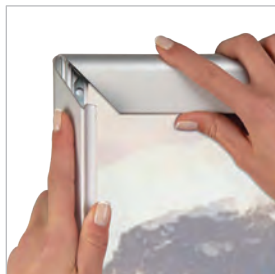

Front opening snapframes for quick and easy poster change.



## Snapframes to match your branding.

### Silver Anodised

15, 25 or 38mm standard and 25mm or 42mm security profiles.

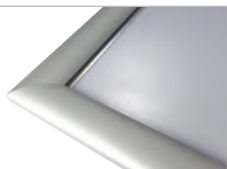

\* Standard sizes in stock – see page 79

- No minimum order quantity.
- Fast lead times – typically, 1-10 frames (3-5 days), 11-25 frames (5-7 days).
- Almost any size (minimum poster size: 210 x 210mm).
- Oversize frames (>1.5m<sup>2</sup>) may require collecting by customer if too large for our parcel delivery provider or for palletising.



**Black\***  
RAL 9005  
(25 & 38mm)



**Signal White\***  
RAL 9003  
(25 & 38mm)



**Traffic Red**  
RAL 3020  
(25 & 38mm)

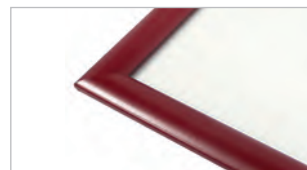

**Burgundy Red**  
RAL 3004  
(25 & 38mm)



**Ultramarine Blue**  
RAL 5002  
(25 & 38mm)

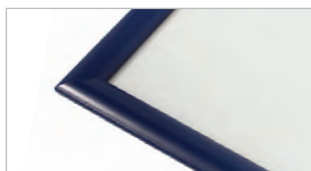

**Sapphire Blue**  
RAL 5003  
(25 & 38mm)



**Moss Green**  
RAL 6005  
(25 & 38mm)

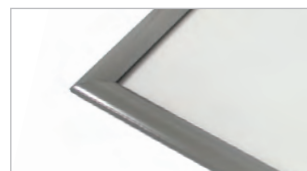

**Dusty Grey**  
RAL 7037  
(25 & 38mm)



**Gold**  
(25mm only)



**Wood**  
(25mm only)

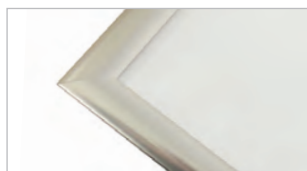

**Satin Chrome** (25mm)  
**Bright Chrome** (38mm)

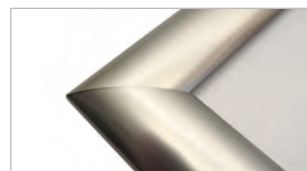

**Stainless Steel**  
(25mm only)

# CUSTOM MANUFACTURING SERVICE

## Vast range of colours and finishes available

(minimum order quantity may apply in some cases).

## Almost any size

From A6 (105 x 148mm) poster size.

## Range of frame profiles

All standard, security and lockable styles.

12 stock finishes plus silver anodised in a selection of profiles to support our *Express Made to Order Service*.



## STANDARD SNAPFRAMES

Quick and easy poster display for indoor and outdoor use.

15mm Profile with Mitred Corners – **Silver**

Poster Size	Display Area (mm)	O/A Dimensions (w x h mm)	Stock Status	Finish	Order Code
A6	85 x 128	115 x 158	Made to order	Silver	SNA615SA(M)
A5	127 x 188	158 x 220	In stock	Silver	SNA515SA(W)
				Black	SNA515BLK(W)
A4	188 x 275	225 x 306	In stock	Silver	SNA415SA(W)
A3	277 x 400	307 x 430	In stock	Silver	SNA315SA(W)
A2	400 x 574	430 x 604	Made to order	Silver	SNA215SA(M)
20" x 30"	488 x 742	518 x 772	Made to order	Silver	SN2315SA(M)
A1	574 x 821	604 x 851	Made to order	Silver	SNA115SA(M)

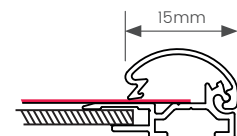



## 25mm Profile with Mitred Corners - Silver

Poster Size	Display Area (mm)	O/A Dimensions (w x h mm)	Availability	Order Code
A5	133 x 195	184 x 246	Made to order	SNA525SA(M)
A4	190 x 277	240 x 325	In stock	SNA425SA(P)
A3	275 x 399	327 x 448	In stock	SNA325SA(P)
A2	400 x 575	450 x 625	In stock	SNA225SA(P)
495 x 708	477 x 690	528 x 740	In stock	SN49570825SA(W)
20" x 30"	492 x 746	544 x 797	In stock	SN2325SA(P)
A1	576 x 825	627 x 875	In stock	SNA125SA(W)
30" x 40"	747 x 1001	798 x 1052	Made to order	SN3425SA(M)
A0	826 x 1174	877 x 1225	Made to order	SNA025SA(M)
40" x 60"	1001 x 1509	1052 x 1560	Made to order	SN4625SA(M)

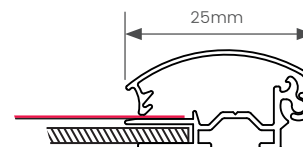

## 25mm Profile with Round Corners - Silver

Poster Size	Display Area (mm)	O/A Dimensions (w x h mm)	Stock Status	Order Code
A5	133 x 195	184 x 246	Made to order	SNRA525SA(M)
A4	195 x 282	245 x 333	In stock	SNRA425SA(P)
A3	275 x 400	325 x 450	In stock	SNRA325SA(P)
A2	405 x 580	455 x 630	In stock	SNRA225SA(P)
20" x 30"	492 x 745	545 x 797	In stock	SNR2325SA(P)
A1	580 x 825	630 x 875	In stock	SNRA125SA(W)
30" x 40"	747 x 1001	798 x 1052	Made to order	SNR3425SA(M)
A0	826 x 1174	877 x 1225	Made to order	SNRA025SA(M)
40" x 60"	1001 x 1509	1052 x 1560	Made to order	SNR4625SA(M)

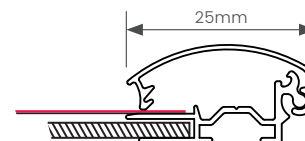

## 25mm Profile with Mitred Corners - Black

Poster Size	Display Area (mm)	O/A Dimensions (w x h mm)	Availability	Order Code
A4	190 x 277	240 x 325	In stock	SNA425BLK(P)
A3	275 x 399	327 x 448	In stock	SNA325BLK(P)
A2	400 x 575	450 x 625	In stock	SNA225BLK(P)
20" x 30"	492 x 746	544 x 797	In stock	SN2325BLK(P)
A1	576 x 825	627 x 875	In stock	SNA125BLK(W)

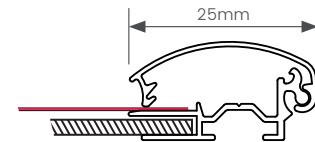

## 25mm Profile with Mitred Corners - White

Poster Size	Display Area (mm)	O/A Dimensions (w x h mm)	Availability	Order Code
A4	190 x 277	240 x 325	In stock	SNA425WT(P)
A3	275 x 399	327 x 448	In stock	SNA325WT(P)
A2	400 x 575	450 x 625	In stock	SNA225WT(P)
20" x 30"	492 x 746	544 x 797	In stock	SN2325WT(P)
A1	576 x 825	627 x 875	In stock	SNA125WT(W)

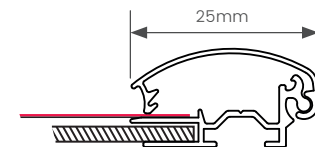

## 32mm Profile with Mitred Corners - Silver

Poster Size	Display Area (mm)	O/A Dimensions (w x h mm)	Availability	Order Code
A4	190 x 280	255 x 340	In stock	SNA432SA(W)
A3	275 x 400	340 x 465	In stock	SNA332SA(W)
A2	400 x 575	465 x 640	In stock	SNA232SA(W)
20" x 30"	490 x 745	550 x 805	In stock	SN203032SA(W)
A1	575 x 820	635 x 885	In stock	SNA132SA(W)
30" x 40"	740 x 995	805 x 1060	In stock	SN304032SA(W)
A0	820 x 1170	880 x 1230	In stock	SNA032SA(W)
40" x 60"	995 x 1505	1055 x 1565	In stock	SN406032SA(W)

Also available with round corners (made to order).

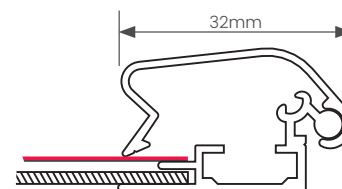

## 38mm Profile with Mitred Corners - Silver

Poster Size	Display Area (mm)	O/A Dimensions (w x h mm)	Weight (kg)	Availability	Order Code
A3	266 x 389	342 x 465	1.1	Made to order	SNA338SA(M)
A2	389 x 563	465 x 639	1.8	Made to order	SNA238SA(M)
20" x 30"	477 x 731	553 x 807	2.1	Made to order	SN2338SA(M)
A1	563 x 810	639 x 886	2.9	Made to order	SNA138SA(M)
30" x 40"	725 x 980	800 x 1050	3.9	In stock	SN3438SA(W)
A0	805 x 1154	888 x 1230	4.6	In stock	SNA038SA(W)
40" x 60"	980 x 1490	1060 x 1570	3.5	In stock	SN4638SA(W)

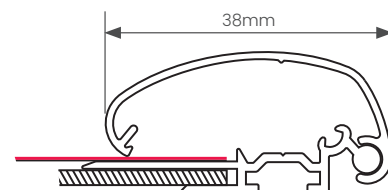

# MINIMUS

Patent No. 2531204

## The lowest cost snapframe in the world.

Minimus Snapframes may not have a back panel but they provide a great way to display posters, advertisements and information on flat surfaces.

Our patented corner mouldings and high strength serrated springs keep the frame strong, secure and dependable.

- 25mm silver anodised profile.
- 4 stock poster sizes: A4, A3, A2 and A1.
- UV stable anti-glare poster cover sheet.
- Suitable for screw fixing or adhesive mounting (each unit individually boxed with set of screws, wall plugs and adhesive pads).
- If used outdoors laminated posters are recommended.



Fix in place.



Insert poster and cover sheet.



Close the sides.



In stock



Fully Recyclable

Poster Size	Display Area (mm)	O/A Dimensions (w x h mm)	Weight (kg)	Availability	Order Code
A4	200 x 285	250 x 335	0.14	In stock	MINIMUSA4
A3	283 x 407	334 x 457	0.19	In stock	MINIMUSA3
A2	406 x 580	458 x 630	0.33	In stock	MINIMUSA2
A1	582 x 828	633 x 880	0.42	In stock	MINIMUSA1

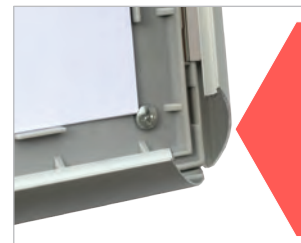

Patented corner mouldings with high tension serrated springs ensure strong grip on the poster

# SECURITY SNAPFRAMES

Posters are kept safe and secure, making these frames ideal for those spaces at risk of unwanted tampering.

- Easily opened by our hand-held opening tool (available separately).
- Available in 2 profile sizes (25mm and 42mm).
- Supplied with anti-glare poster cover sheets for clear poster display.
- Pre-drilled and individually boxed with screws and wall plugs.
- Suitable for either indoor or outdoor use.
- Silver anodised finish as standard – 25mm profile available in almost any RAL colour through our bespoke snapframe service.



Hand-held opening tool.



## 25mm Profile with Mitred Corners

Poster Size	Display Area (mm)	O/A Dimensions (w x h mm)	Weight (kg)	Availability	Order Code
A4	195 x 282	245 x 332	0.34	In stock	SNSA425SA (W)
A3	282 x 405	332 x 450	0.5	In stock	SNSA325SA (W)
A2	405 x 578	455 x 630	0.75	In stock	SNSA225SA (W)
20" x 30"	493 x 745	543 x 796	1.0	In stock	SNS2325SA (W)
A1	577 x 825	628 x 875	1.2	In stock	SNSA125SA (W)
30" x 40"	748 x 1002	798 x 1052	3.5	Made to order	SNS3425SA (M)
A0	827 x 1175	877 x 1225	4	Made to order	SNSA025SA (M)
40" x 60"	1002 x 1510	1052 x 1560	6	Made to order	SNS4625SA (M)

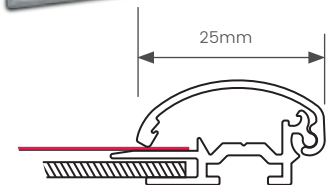

## 42mm Profile with Mitred Corners

Poster Size	Display Area (mm)	O/A Dimensions (w x h mm)	Weight (kg)	Availability	Order Code
A3	256 x 379	340 x 463	1.3	Made to order	SNSA342SA (M)
A2	379 x 553	463 x 637	1.9	Made to order	SNSA242SA (M)
20" x 30"	467 x 721	551 x 805	2.3	Made to order	SNS2342SA (M)
A1	553 x 800	637 x 884	2.8	Made to order	SNSA142SA (M)
30" x 40"	722 x 977	807 x 1065	3.5	In stock	SNS3442SA
A0	800 x 1147	890 x 1230	4.8	In stock	SNSA042SA
40" x 60"	975 x 1482	1060 x 1565	6	In stock	SNS4642SA

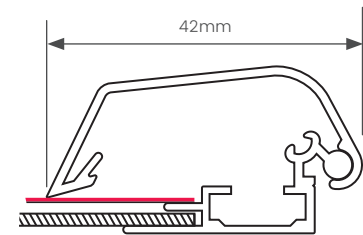



# LOCKABLE SNAPFRAMES

## The best security yet.

- Opens via simple Allen Key operation (included).
- Sides open sequentially for added security.
- Ideal for unmonitored locations.
- Available in 32mm profile.
- Supplied with anti-glare poster cover sheets for clear poster display.
- Pre-drilled and individually boxed with screws and wall plugs.
- Suitable for indoor and outdoor use.
- Silver anodised finish as standard, customisable if required.



Opens via simple Allen key operation.

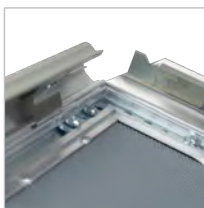

Sequentially closing sides.



Anti-glare cover sheet included.



Easy to insert and change poster.



## 32mm Profile with Mitred Corners

Poster Size	Display Area (mm)	O/A Dimensions (w x h mm)	Weight (kg)	Availability	Order Code
A4	190 x 280	255 x 340	0.56	In stock	SNLKA432SA(W)
A3	280 x 402	345 x 465	0.75	In stock	SNLKA332SA(W)
A2	400 x 575	464 x 640	1.1	In stock	SNLKA232SA(W)
495 x 708	475 x 690	540 x 750	1.3	In Stock	SNLK49570832SA(W)
20" x 30"	490 x 742	552 x 805	1.4	In stock	SNLK203032SA(W)
A1	575 x 822	640 x 885	1.62	In stock	SNLKA132SA(W)
30" x 40"	740 x 997	805 x 1058	2	In stock	SNLK304032SA(W)
A0	822 x 1170	885 x 1230	2.5	In stock	SNLKA032SA(W)
40" x 60"	995 x 1155	1057 x 1565	3.5	In stock	SNLK406032SA(W)



In stock



Fully Recyclable

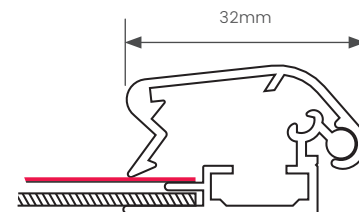

# COUNTERSTAND SNAPFRAMES

## Stylish counter top poster frames.

- Front opening aluminium snapframes, for quick and easy poster change.
- Freestanding for versatile/tactical positioning.
- Clip-fit rear stay enables either portrait or landscape presentation.
- Anti-glare PET poster cover ensures clarity of message under spotlight.
- Includes screws and wall plugs for optional wall mounting



Clip-fit rear stay



Black



Wood

Silver

Poster Size	Frame Width (mm)	Display Area (mm)	O/A Dimensions (w x h mm)	Weight (kg)	Availability	Finish	Order Code
A6	14	95 x 138	126 x 169	0.16	Made to order	Silver	OPTIA625SA
						Black	OPTIA625BLK
						Wood	OPTIA625WD
A5	14	138 x 200	170 x 232	0.17	In stock	Silver	OPTIA514SA
						Black	OPTIA514BLK
						Wood	OPTIA514WD
A4	25	190 x 277	240 x 327	0.39	In stock	Silver	OPTIA425SA
						Black	OPTIA425BLK
						Wood	OPTIA425WD



**In stock**  
A5 & A4



**No tools assembly**



**Fully Recyclable**

# CABLE SUSPENDED SNAPFRAMES

## Poster display from floor to ceiling.

- Double sided poster display for floor to ceiling/wall mounting.
- Front opening snapframes (25mm) for quick and easy poster change.
- Includes anti-glare poster covers.
- Silver anodised finish as standard.
- Also available in any RAL colour (made to order, minimum order quantity 25).
- Cable sold per metre to meet individual height requirements.



2 stoppers required per frame.



Stopper grips cable at adjustable height.



Ceiling/Floor hanger.

### Wire System Components

Item	Stopper for Frames	Ceiling/Floor Hanger	Cable	Basic Ceiling Hanger
Availability	In stock	In stock	In stock	In stock
Order Code	FASF	FACFH	FAWC	FACH

### Double-Sided Snapframes – 25mm Profile with Mitred Corners

Poster Size	Display Area (mm)	O/A Dimensions (w x h mm)	Weight (kg)	Availability	Order Code
A4	190 x 275	242 x 325	0.74	In stock	SNDSA425SA
A3	275 x 400	327 x 450	1.0	In stock	SNDSA325SA
A2	400 x 572	450 x 623	1.69	In stock	SNDSA225SA
A1	576 x 823	624 x 871	3.1	Made to order	SNDSA125SA

**Please note:** the stock options listed here are only suitable for portrait display and with the same sizes used in series, due to cable entry/exit points. Landscape/portrait and different size snapframes for use in the same display are available made to order.



#### In stock

All snapframe made to order



**20 minutes to assemble**



#### Recyclable

Aluminium frames and PET poster covers

## Unlike any other poster frames available, Frameworkz Snapframes can be digitally printed with almost any design.

From logos and text to images and patterns, the choice is yours and the opportunities are truly endless.

- Front opening aluminium snapframes for quick and easy poster change.
- Suitable for external use (2-3 years in temperate climates).
- Minimal distance between frame and poster allows design to 'cross over'.
- Anti-glare 500 micron PET poster covers as standard or optional 750 micron gloss clear polycarbonate at additional cost.
- Pre-drilled for wall mounting.
- Available in any frame size from A3 to 40" x 60".



**Made to order**  
Minimum order quantity 10



**Recyclable**  
Aluminium frames and PET poster covers. Mechanical fixings throughout for easy 'end of life' recycling

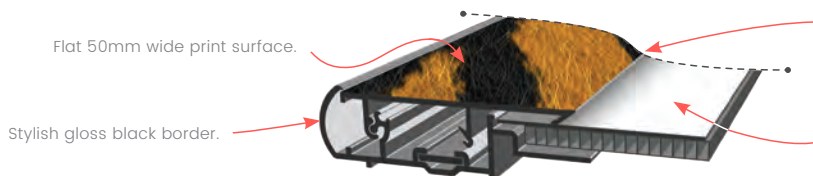

When closed, all fixings and opening method are hidden from view.

Minimal distance between frame and poster allows design to 'cross over'.

Due to frame cutting and artwork tolerances of +/- 1mm, a visible 'step' across the mitred corners is sometimes unavoidable. Designs featuring straight lines across the corners will be particularly prone to this.

Poster Size	Display Area (mm)	O/A Dimensions (w x h mm)	Profile Depth (mm)
Any size from A3 to 40" x 60"	Poster -31.5	Poster +79	15



**ŠKODA  
RAPID  
SPACEBACK S**



**Request a  
test drive here**



**ŠKODA**  
*Lancaster*



# Non-Illuminated Poster Frames & Noticeboards

- 
- **Slimlok Poster Case**
  - **Slimlok Menu Case**
  - **Slimlok Noticeboard**
  - **Hi-Sight**
  - **Headliner**
  - **Poster Pillars**
- 

Our selection of Non-Illuminated Poster Frames and Noticeboards offer an array of solutions for poster, banner and menu presentation.

The range includes our market leading **Slimlok Menu Case**, great for temporary poster promotions. Our original **Slimlok Poster Case** offers retailers a truly lockable display solution. Both are available in a range of standard sizes in a choice of up to 8 stock colours with no minimum order quantity. Additional colours, bespoke sizes and even permanent branding can also be accommodated, although minimum order quantities may apply in some cases.

Our innovative **Headliner** makes window displays professional, presentable and cost effective. Commonly seen in convenience stores, post offices and supermarkets, the **Headliner** provides an updateable poster display for windows, doors and clear surfaces.

# SLIMLOK POSTER CASE

## Stylish poster display cases with lockable doors.

- 52 x 30mm profile durable aluminium frame.
- Vandal resistant 1.5mm polycarbonate glazing panel.
- Internal clips hold posters securely in place and allows for quick and easy poster changes.
- Ideal for outdoor use.
- Door stays supplied as standard on silver units at A1 or larger (optional on black units).
- Each poster case supplied with a set of keys.
- For added security, poster sizes A1 and larger have two locks.

### Express made to order:

**Stock Colours:**  
No minimum order quantity

**Black**

RAL 9005

**Signal White**

RAL 9003

**Dusty Grey**

RAL 7037

**Traffic Red**

RAL 3020

**Burgundy Red**

RAL 3004

**Ultramarine Blue**

RAL 5002

**Sapphire Blue**

RAL 5003

**Moss Green**

RAL 6005



**In stock**

Silver anodised and black



**Recyclable**

Aluminium frames and polycarbonate glazing panels



Poster Size	Display Area (mm)	O/A Dimensions (w x h x d mm)	Weight (kg)	Order Code (without door stays)		Order Code (with door stays)	
				Silver	Black	Silver	Black
A4	186 x 273	291 x 378 x 32	2	SKA4MK3(W)	SKA4MK3BLK	-	-
A3	273 x 396	378 x 501 x 32	2.5	SKA3MK3(W)	SKA3MK3BLK	-	-
A2	396 x 570	501 x 675 x 32	3.5	SKA2MK3(W)	SKA2MK3BLK	-	-
20" x 30"	484 x 738	589 x 843 x 32	5	SK2030MK3(W)	SK2030MK3BLK	-	-
A1	570 x 817	675 x 922 x 32	6	-	-	SKA1MK3WS(W)	SKA1MK3WSBLK
30" x 40"	738 x 992	843 x 1097 x 32	8	-	-	SK3040MK3WS(W)	SK3040MK3WSBLK
A0	817 x 1165	922 x 1270 x 32	9	-	-	SKA0MK3WS(W)	SKA0MK3WSBLK
40" x 60"	992 x 1500	1097 x 1605 x 32	13	-	-	SK4060MK3WS	SK4060MK3WSBLK

Other standard and non-standard sizes are available made to order with or without stays. Call your sales advisor for more details.

# SLIMLOK MENU CASE

## Featuring a magnetic/dry wipe back panel and header area.

- 52 x 30mm profile durable silver anodised aluminium frame.
- Vandal resistant 1.5mm polycarbonate glazing panel.
- Magnetic pins included.
- Suitable for internal or external use, with portrait orientation.
- Door stays fitted as standard on 4 x A4 model.
- Each menu case supplied with a set of keys.
- Glazing panels suitable for self adhesive vinyl or direct to surface print.
- Back panel is ideal for vinyl application.



Also available as an illuminated display (see page 109).

### Express made to order:

**Stock Colours:**  
Minimum order quantity 3

**Black**  
RAL 9005

**Signal White**  
RAL 9003

**Dusty Grey**  
RAL 7037

**Traffic Red**  
RAL 3020

**Burgundy Red**  
RAL 3004

**Ultramarine Blue**  
RAL 5002

**Sapphire Blue**  
RAL 5003

**Moss Green**  
RAL 6005



Door stays fitted as standard on 4 x A4 model.



Supplied with set of magnetic pins.



**In stock**



**Recyclable**  
Aluminium frames and polycarbonate glazing panels

**Available in 4 stock sizes**

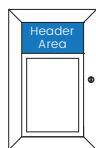

**1 x A4**

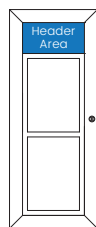

**2 x A4 Vertical**

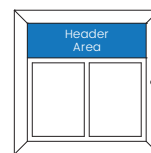

**2 x A4 Horizontal**

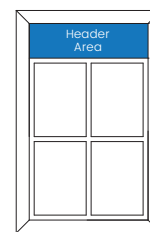

**4 x A4\***

O/A Dimensions (w x h x d mm)	355 x 567 x 32	355 x 884 x 32	585 x 579 x 32	585 x 899 x 32
Header Size (mm)	251 x 125	251 x 125	481 x 140	481 x 140
Approx. Weight (kg)	3	5	5	7
Order Code	SKMC1XA4MK3	SKMC2XA4VERTMK3	SKMC2XA4HORIMK3	SKMC4XA4MK3

Also available in custom sizes (minimum order quantity 5). \* Door stays fitted as standard.

# SLIMLOK NOTICEBOARD

Stylish poster display case with lockable doors and magnetic/dry wipe back panel.

- 52 x 30mm profile durable silver anodised aluminium frame.
- Vandal resistant 1.5mm polycarbonate glazing panel.
- Magnetic pins included.
- Suitable for internal or external use, landscape or portrait.
- Door stays fitted as standard on all models.
- Each noticeboard supplied with a set of keys.
- Back panel suitable for dry wipe messaging and vinyl application.

**Express made to order:**

**Stock Colours:**  
No minimum order quantity

**Black**

RAL 9005

**Signal White**

RAL 9003

**Dusty Grey**

RAL 7037

**Traffic Red**

RAL 3020

**Burgundy Red**

RAL 3004

**Ultramarine Blue**

RAL 5002

**Sapphire Blue**

RAL 5003

**Moss Green**

RAL 6005

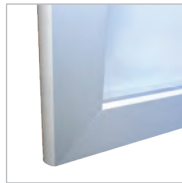

Durable aluminium frames.



Door stays fitted as standard on all models.



**In stock**



**Recyclable**

Aluminium frames and polycarbonate glazing panels



4x4A shown.

Available in 4 stock sizes

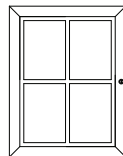

4 x A4

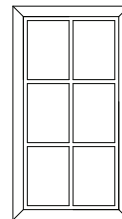

6 x A4

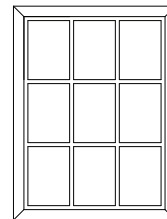

9 x A4

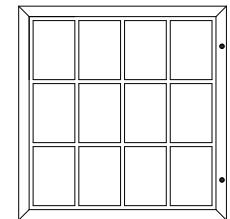

12 x A4

O/A Dimensions (w x h x d mm)	585 x 759 x 32	585 x 1076 x 32	815 x 1076 x 32	1045 x 1076 x 32
Weight (kg)	6.4	8	12	14.8
Order Code	NB4XA4MK3	NB6XA4MK3	NB9XA4MK3	NB12XA4MK3

Also available in custom sizes (minimum order quantity 5).

# FELT SHOWBOARD

High quality felt notice boards in a range of sizes and colours.

- Suitable for internal use in portrait or landscape format.
- Available in 4 sizes with red, blue, green or grey felt backing.
- Suitable for use with Velcro and pins.
- Silver anodised aluminium frames (profile width: 45mm) with PETG glazing panels and galvanised steel back panels.
- Lockable doors for security (1 lock on 4 x A4 size, 2 locks on all other sizes).
- Supplied complete with set of pins, screws, wall plugs and a pair of keys.



4xA4 shown.

Size	Display Area (mm)	O/A Dimensions (w x h x d mm)	Weight (kg)	Felt Colour	Availability	Order Code
4 x A4	483 x 653	585 x 755 x 36	8.5	Red	Made to order	SWF4XA4RD
				Blue	In stock	SWF4XA4BL
				Green	Made to order	SWF4XA4GR
				Grey	In stock	SWF4XA4GY
6 x A4	483 x 973	585 x 1075 x 36	10.4	Red	Made to order	SWF6XA4RD
				Blue	In stock	SWF6XA4BL
				Green	Made to order	SWF6XA4GR
				Grey	In stock	SWF6XA4GY
9 x A4	713 x 973	815 x 1075 x 36	14.1	Red	Made to order	SWF9XA4RD
				Blue	In stock	SWF9XA4BL
				Green	Made to order	SWF9XA4GR
				Grey	In stock	SWF9XA4GY
12 x A4	943 x 973	1045 x 1075 x 36	18	Red	Made to order	SWF12XA4RD
				Blue	In stock	SWF12XA4BL
				Green	Made to order	SWF12XA4GR
				Grey	In stock	SWF12XA4GY



**In stock**



**No tools  
assembly**



**Recyclable**  
Aluminium frames and PETG  
Panel



# HI-SIGHT

Registered Design No. 000879876

Thanks to its unique 'pull down' poster cartridge, the Hi-Sight has many advantages over traditional poster frames.

- Can be mounted up to 3 times higher than a regular frame.
- Quicker, easier and safer, no need to stretch or use ladders.
- Reduced risk of tampering and vandalism.
- Hard wearing aluminium frame.
- Fixed polycarbonate cover with magnetic seals, virtually no risk of poster loss.
- Excellent weather resistance.
- Suitable for indoor and outdoor use.
- Hidden pre-drilled holes, ready for wall mounting.



Apply finger pressure just above border and lift.



Poster cover security fixings.



Internal frame detail.



Ideal for out of town retailers. The Hi-Sight maximises visibility of store front promotions – vital in the drive for greater awareness and increased sales.



Traditional frames – low visibility.



Hi-Sight – high visibility!



Posters are held in place by 4 'pinch' holders on top of cartridge



Open 'poster-pinch' mounts to add or change posters.

Place poster within 'poster-pinch' opening.

Close 'poster-pinch' mounts to pierce and grip poster.

Poster Size	Display Area (mm)	O/A Dimensions (mm)	Weight (kg)	Order Code
30" x 40"	751 x 990	858 x 1122	7.2	HIS34SA(s)
A0	830 x 1163	937 x 1295	8.4	HISA0SA(s)
40" x 60"	1005 x 1498	1112 x 1630	12	HIS46SA(s)

Also available with colour borders (minimum order quantity 25).



Pull down poster cartridge for safe, quick and easy poster change.



**In stock**



**No tools assembly**



**Recyclable**

Aluminium frames and polycarbonate poster cover

# HEADLINER

## High visibility fixed poster display for windows and doors.

- Mounted directly to inside of glass with pre-applied clear double sided tape, no need for messy Sellotape or Blu Tack.
- Prime positioning for permanent brand presence.
- Hard wearing poster wallet\* with magnetic seals ensures poster stays clean, dry and presentable.
- Available with square or rounded corners, with or without headers.



### Made to order

Minimum order quantity 25



### No tools assembly

### Standard sizes:

A4, A3, A2, A1 and 20" x 30"  
(minimum order quantity 25).

Round corners  
with constant  
border

Square corners  
with constant  
border

Round corners  
with header

Square corners  
with header



Magnetic seals make it quick and easy to change posters.



## Custom shapes and sizes available



### Made to order

Minimum order quantity 100

\* PVC poster wallet for sizes: A4, A3, A2

Polycarbonate poster wallet for sizes: A1 & 20" x 30"



# HEADLINERLITE

Incredibly simple, cost effective and repositionable window poster display.

- Versatile holder for single or double sided poster display.
- Vacuum suckers and keyhole cut outs make it incredibly quick and easy to install (no tools required).
- Change posters in seconds – simply lift cover, replace poster and slot cover back in place.
- Consists of two cover sheets (UV stable 700 micron PET) and four vacuum suckers.
- Stock product sold/packed in pairs with window surface cleaning wipes and instructions.
- Available in 3 stock sizes: A3, A2 and A1.
- Printed borders available (30mm all round) made to order. Minimum order quantity 25.



Window suckers for quick and easy installation and poster change.



Printed borders available. Minimum order quantity 25.

Available in 3 stock sizes

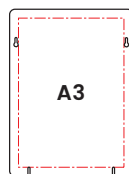

A3

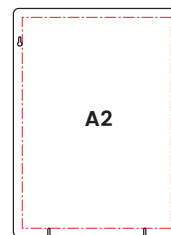

A2

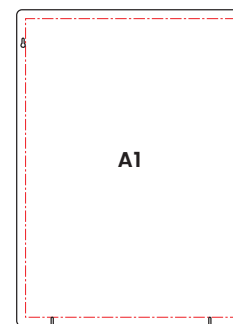

A1



In stock



No tools assembly



Fully Recyclable

<b>Display Area (mm)</b> Standard clear border	297 x 420	420 x 594	594 x 841
<b>Display Area (mm)</b> with 30mm printed border	287 x 410	410 x 584	584 x 831
<b>O/A Dimensions (mm)</b>	347 x 470	470 x 644	644 x 891
<b>Box Dimensions (mm)</b>	352 x 475 x 30	475 x 650 x 30	650 x 900 x 30
<b>Weight (kg)</b>	1	1.8	3.3
<b>Order Code (pack of 2)</b>	HEADLINERLITEA3	HEADLINERLITEA2	HEADLINERLITEA1



# POSTER SNAP

## Lightweight display solution for paper posters.

- Each set consists of a pair of 26mm aluminium snapframe rails with black end caps and adjustable hanging clips.
- Ideal for wall mounting but can be suspended for window display.
- Silver anodised finish as standard, also available in any RAL colour (minimum order quantity 100).

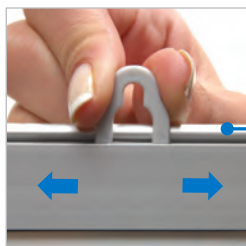

Adjustable hanging clips.



Slide poster into the rail...



...and close the rail onto the poster.



**In stock**  
Certain sizes made to order



**No tools assembly**



**Recyclable**  
Aluminium snapframe rails

Poster Width (mm)	Weight (kg)	Availability	Order Code
210 (e.g. A5 or A4)	0.15	Made to order	PS210
300 (e.g. A4 or A3)	0.2	In stock	PS297
420 (e.g. A3 or A2)	0.25	In stock	PS420
500	0.3	In stock	PS50
600 (e.g. A2 or A1)	0.4	In stock	PS594
700	0.45	Made to order	PS700
850 (e.g. A1 or A0)	0.5	In stock	PS841
1000	0.6	Made to order	PS1000
1200	0.7	Made to order	PS1200

Available in custom sizes made to order (minimum order quantities apply).



# POSTER CLAMP

Heavy duty gripping action for materials up to 0.5mm thick.

- Ideal for large/heavy weight posters, banners and textiles up to 500 micron thick.
- Each set consists of 2 x 25mm aluminium rails and 2 adjustable hanging clips.
- Ideal for wall mounting but can be suspended for window display.
- Silver anodised finish as standard, also available in any RAL colour (minimum order quantity 100).



Adjustable hanging clips with key hole cut-out and cable hole for wall mounted or hanging display.



Insert poster...



...and close clamp.



**In stock**  
Certain sizes  
made to order



**No tools  
assembly**



**Recyclable**  
Aluminium rails

Poster/Banner Width (mm)	Weight (kg)	Availability	Order Code
210 (e.g. A5 or A4)	0.26	Made to order	PC210(M)
300 (e.g. A4 or A3)	0.29	Made to order	PC297(M)
420 (e.g. A3 or A2)	0.4	Made to order	PC420(M)
500	0.5	In stock	PC500(M)
600 (e.g. A2 or A1)	0.5	Made to order	PC594(M)
700	0.65	In stock	PC700(M)
850 (e.g. A1 or A0)	0.75	Made to order	PC841(M)
1000	0.95	In stock	PC1000(M)
1200	1	Made to order	PC1200(M)

Available in custom sizes made to order (minimum order quantities apply).

# POSTER HANGER

Perfect for flexible banner materials and rigid plastics up to 1mm thick.

- Plastic grippers make it easy to insert and remove graphics.
- Ideal for ceiling suspension due to fixings being positioned on the top of the rail. Suitable for wall mounting also.
- Silver anodised finish as standard, also available in any RAL colour (minimum order quantity 100).

## Each set consists of:

- 2 aluminium rails (slim 20mm wide) with end caps and poster/ banner grippers (2 or 3 per rail depending on size).
- Adjustable hanging clips on top rail.



Remove grippers from rail...

...push onto poster...

...and insert back into rail.

Adjustable hanging clips with key hole cut-outs for either ceiling suspension or wall hanging.

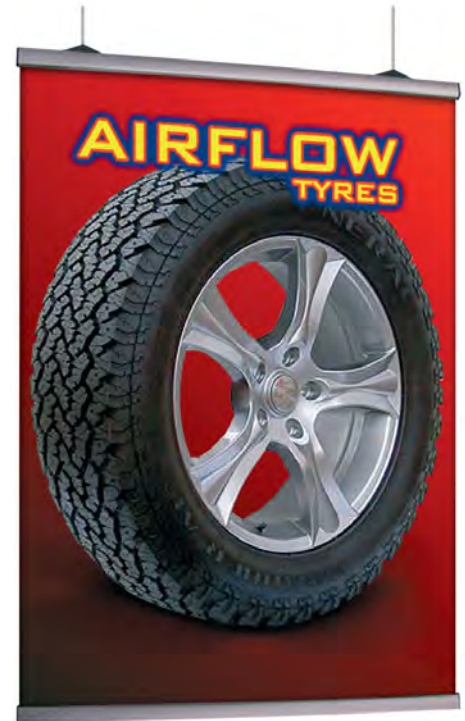

### In stock

Certain sizes made to order



### No tools assembly



### Recyclable

Aluminium snapframe rails

Poster/Panel Width (mm)	Weight (kg)	Availability	Order Code
210 (e.g. A5 or A4)	0.1	Made to order	PFX210
300 (e.g. A4 or A3)	0.15	In stock	PFX300
420 (e.g. A3 or A2)	0.2	In stock	PFX420
500	0.22	Made to order	PFX500
600 (e.g. A2 or A1)	0.25	In stock	PFX594
700	0.3	Made to order	PFX700
850 (e.g. A1 or A0)	0.35	In stock	PFX841
1000	0.4	Made to order	PFX1000
1016 (e.g. 30" x 40" or 40" x 60")	0.45	In stock	PFX1016
1200	0.5	In stock	PFX1200

Available in custom sizes made to order (minimum order quantities apply).

# SIGN NAV

## Versatile way finding display for walls and doors.

- Tamper proof yet easy to open with suction cup provided.
- Anti-reflective covers ensure clarity of message.
- Self adhesive strips on reverse for quick and easy installations, no tools or drilling needed.
- Easy to create/update message using any desktop printer.
- Suitable for paper, plastic or any flexible material up to 1mm thick.
- Gives a high quality finish to any message.
- Available in 5 stock sizes, plus a wide range of other sizes available made to order.
- All models suitable for landscape or portrait display.



All models suitable for landscape or portrait display.



Easily open the display with suction cup provided.



Cover can be pressed into place.



Self-adhesive strips for no tools installation.

### Available in 5 stock sizes

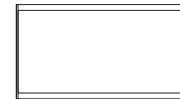
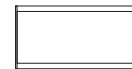
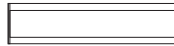

<b>Poster Size</b> (mm)	150 x 52	300 x 52	150 x 74	250 x 105	300 x 148
<b>Display Area</b> (mm)	150 x 46	300 x 46	150 x 68	250 x 99	300 x 142
<b>O/A Dimensions</b> (w x h x d mm)	156 x 68 x 14	306 x 68 x 14	156 x 90 x 14	256 x 120 x 14	306 x 162 x 14
<b>Weight</b> (kg)	0.1	0.2	0.1	0.3	0.4
<b>Order Code</b>	SNAV52X15	SNAV52X30	SNAV74X15	SNAV105X25	SNAV148X30



**In stock**  
Certain sizes  
made to order



**No tools  
assembly**



**Recyclable**  
Aluminium frame and PET poster covers

# INFO BOARD

## A1 poster display with optional acrylic brochure shelves.

- Single or double sided A1 poster display.
- Other sizes available (made to order).
- Front opening aluminium snapframes for quick and easy poster changes (silver anodised finish).
- Anti-glare PET poster covers.
- Optional acrylic brochure shelves (available separately). Made with transparent 4mm acrylic, single or double sided, for 2 or 4 x A4 brochures respectively.

### Optional Acrylic Brochure Shelves



Made with 4mm transparent acrylic.

Single or double sided shelves available.

Shelf Type	Capacity	Dimensions (w x d mm)	Weight (kg)	Order Code
Single sided	2 x A4	440 x 40	1	INFOSHLFSG
Double sided	4 x A4	440 x 40	2	INFOSHLFDS

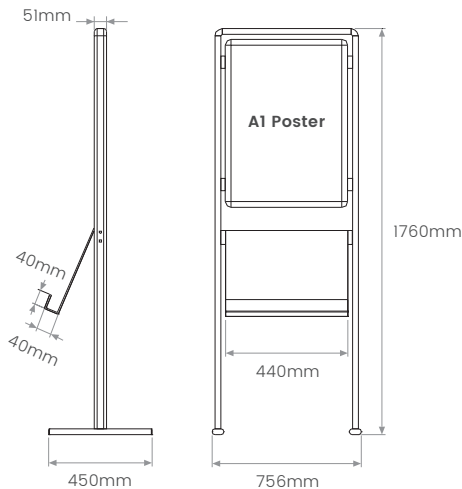

Poster Size	O/A Dimensions (w x h x d mm)	Type	Pack Weight (kg)	Availability	Order Code
500 x 700mm	660 x 1760 x 450	Single-sided	8.0	Made to order	INFOSG500
		Double-sided	9.5		INFODS500
A1	756 x 1760 x 450	Single-sided	8.8	In stock	INFOSGA1
		Double-sided	11.1		INFODSA1
700 x 1000mm	860 x 1760 x 450	Single-sided	11.0	Made to order	INFOSG700
		Double-sided	13.75		INFODS700



**In stock**



**No tools assembly**



**Recyclable**

Aluminium frame, polycarbonate poster cover and acrylic shelves

# POSTER PILLAR

## Single or double tiered freestanding poster display.

- Simple, functional, low cost double sided design.
- Posters/panels simply slide into place.
- Aluminium frames with a choice of silver anodised or black powder coated finish.
- Black polystyrene (HIPS) inner sheets provide light block between back to back posters.
- Protective anti-glare PET poster cover sheets.
- Allen key and instructions supplied with each unit.
- Black Poster Pillars made to order.

### Simple slide-in assembly method:

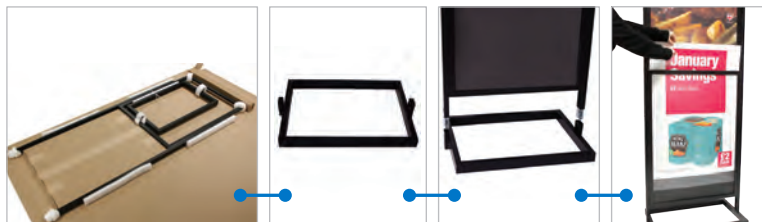

Type	Poster/Panel Size (mm)	Display Area (mm)	O/A Dimensions (w x h x d mm)	Weight (kg)	Finish	Availability	Order Code
Small Single Tier	500 x 700	472 x 672	562 x 1595 x 380	7.4	Silver	Made to order	PPST500700SA
				7.4	Black		PPST500700BLK
	594 x 841 (A1)	566 x 813	656 x 1595 x 380	8	Silver	Made to order	PPST594841SA
				8	Black		PPST594841BLK
Double Tier	500 x 700 (x2)	472 x 672 (x2)	562 x 1595 x 380	8.9	Silver	Made to order	PPDT500700SA
				8.9	Black		PPDT500700BLK
	594 x 841 (x2)	566 x 813 (x2)	656 x 1820 x 450	10	Silver	In stock	PPDT594841SA
				10	Black		PPDT594841BLK
Large Single Tier	500 x 1700	472 x 1672	561 x 1895 x 380	10.9	Silver	In stock	PPST5001700SA
				10.9	Black		PPST5001700BLK



**5 minutes to assemble**



**Recyclable**  
Aluminium frames, PET poster covers and polystyrene (HIPS) inner sheets



SEIZE THE  
FREEZE



Coca-Cola  
Frozen



TASTE THE FEELING™

© The Coca-Cola Company. All rights reserved. 2013. COCA-COLA is a registered trademark of The Coca-Cola Company.

# Illuminated Poster Frames, Noticeboards & Displays

- 
- **Edgelit XT**
  - **Slimlok Illuminated Menu Case**
  - **D-Light**
  - **Freelight Plus**
  - **Hi-Light Menu Stand**
  - **Illuminated Totem**
- 

Our **Freelight Plus**, the simplest in-store illuminated display at one end of the range (without an electrical component in sight!), to the LED illuminated **Edgelit XT**, with it's exceptional brightness levels, build quality and style.

Low voltage LED illumination features across many of these elements. LED's bring key benefits; quick and easy installation, low power consumption and maintenance-free longevity, all combine to deliver eye catching displays with low running costs built in as standard.

# LED & FLUORESCENT LIGHT INFORMATION

## What's the difference between Fluorescent Lights and an LED?

Our range of illuminated displays incorporate LED or Fluorescent tube lighting depending on the size and structure of each unit. Lamp options are carefully considered during the design of our products to ensure for optimal, efficient and even illumination.

### Benefits of Fluorescent tubes:

Fluorescent bulbs are typically used to light up full rooms, so you can ensure for a full and concise illumination from your display. Although they have a slightly higher energy consumption than their LED counterparts, they can still provide over 10,000 hours of illumination before needing to be replaced.



### Benefits of LED lighting:

LED stands for Light Emitting Diode and converts electricity into a super-efficient, long lasting and instant illumination. They have lifespan of around 50,000 hours before needing to be replaced - which converts to around 6 years of constant illumination. LED also use 90% less energy than Fluorescent bulbs, providing retailers with a cost efficient illuminated option.



## Stylish super-slim LED interior light box

- Slim profile single or double sided snapframe LED interior light box
- Front opening snapframes for quick and easy poster change
- Maintenance free Osram LEDs for even white illumination and 50,000+ hours longevity
- Supplied with anti-reflective poster cover sheets ensuring clarity of message
- Power-efficient illumination offers low running costs for life & environmental benefit
- Direct power feed into the lightbox ensures a clean, unobtrusive frame appearance
- Also available in custom sizes\* and colours (minimum order quantity 5)



Single Sided:

Poster Size	Display Area (mm)	O/A Dimensions (w x h x d mm)	Weight (kg)	Availability	Order Code
A4	189 x 276	240 x 327 x 18	1.07	In Stock	BBLEDA4
A3	276 x 399	327 x 450 x 18	1.58		BBLEDA3
A2	399 x 573	450 x 624 x 18	2.53		BBLEDA2
20" x 30"	487 x 741	538 x 792 x 18	3		BBLED23
A1	573 x 820	624 x 871 x 18	5		BBLEDA1
30" x 40"	741 x 995	792 x 1046 x 18	3.51		BBLED34
A0	820 x 1168	871 x 1219 x 18	5.5		BBLEDA0

Double Sided:

Poster Size	Display Area (mm)	O/A Dimensions (w x h x d mm)	Weight (kg)	Availability	Order Code
A4	189 x 276	240 x 327 x 30	1.28	Made to order	BBDSLEDA4
A3	276 x 399	327 x 450 x 30	2.09		BBDSLEDA3
A2	399 x 573	450 x 624 x 30	3.67		BBDSLEDA2
20" x 30"	487 x 741	538 x 792 x 30	7.01		BBDSLED23
A1	573 x 820	624 x 871 x 30	13.18		BBDSLEDA1
30" x 40"	741 x 995	792 x 1046 x 30	5.3		BBDSLED34
A0	820 x 1168	871 x 1219 x 30	8.02		BBDSLEDA0



12V adaptor supplied with each unit.



3m waterproof extension cable available (page 185).

\*Max size 850 x 1200mm. Max perimeter 4000mm. Max short side 850mm. Max long side 1500mm

# WEATHERPROOF SMART LEDBOX

Highly effective for outdoor use.

- Front opening 35mm satin silver snapframe for quick and easy poster change
- Tamper resistant locking frame with sequential opening
- Suitable for portrait or landscape wall mounting
- Back panel provides strong, even illumination across the entire surface
- White Osram LEDs emitting 6500K optimum colour temperature
- Concealed cable entry ensures low profile frame appearance
- Wall fixings provided
- CE certificate supplied with each unit



12V adaptor supplied with each unit.



3m extension lead available separately (see page 185).



Poster Size	Display Area (mm)	O/A Dimensions (w x h x d mm)	Approx. Weight (kg)	Order Code
30" x 40"	753 x 1007	823 x 1077 x 30	13.25	EXTLED34
A0	832 x 1180	902 x 1250 x 30	14.42	EXTLEDA0
40" x 60"	1007 x 1515	1077 x 1585 x 30	24.37	EXTLED46



**In stock**



**Recyclable**  
Aluminium perimeter frame



## Our stylish 'extra thin' LED Snapframe.

- Specially treated acrylic panel provides strong, even illumination across the entire surface.
- Front opening aluminium snapframes for quick and easy poster change (silver anodised 25mm profile).
- Available single sided or double sided (made to order).
- Anti-glare PET poster covers ensures clarity of message.
- Slim, elegant design: single sided units only 19mm deep.
- Osram LEDs emitting 6500K 'daylight' colour temperature.
- CE certificate supplied with each unit.
- Also available in custom sizes\* and colours (made to order, minimum order quantity 5).



Single Sided:

Poster Size	Display Area (mm)	O/A Dimensions (w x h x d mm)	Weight (kg)	Availability	Order Code
A4	190 x 277	242 x 329 x 19	2.6	Made to order	LEDA4
A3	277 x 400	329 x 452 x 19	3.4	In stock	LEDA3
A2	400 x 574	452 x 626 x 19	4.2	In stock	LEDA2
500 x 700mm	480 x 680	532 x 732 x 19	6.4	Made to order	LED500
20" x 30"	488 x 742	540 x 794 x 19	6.7	Made to order	LED23
A1	574 x 821	626 x 873 x 19	8.1	In stock	LEDA1
700 x 1000mm	680 x 980	732 x 1032 x 19	9.9	Made to order	LED700
30" x 40"	742 x 996	794 x 1048 x 19	10.8	In stock	LED34
A0	821 x 1169	873 x 1221 x 19	13.5	In stock	LEDA0

Double Sided:

Poster Size	Display Area (mm)	O/A Dimensions (w x h x d mm)	Weight (kg)	Availability	Order Code
A4	190 x 277	242 x 329 x 28	3.1	Made to order	LEDDSA4
A3	277 x 400	329 x 452 x 28	4		LEDDSA3
A2	400 x 574	452 x 626 x 28	5.8		LEDDSA2
500 x 700mm	480 x 680	532 x 732 x 28	8		LEDD500
20" x 30"	488 x 742	540 x 794 x 28	8.4		LEDD23
A1	574 x 821	626 x 873 x 28	10		LEDDSA1



Built-in on/off switch.



3m extension lead available separately (see page 181).



### In stock

Single sided A3, A2, A1, A0 & 30" x 40"



### No tools assembly



### Recyclable

Aluminium snapframes, PET poster covers and acrylic panels

\* Max size 850 x 1200mm. Max perimeter 4000mm. Max short side 850mm. Max long side 1500mm.

# ILLUMINATED SLIMLOK MENU CASE

Stylish poster display case with lockable doors and magnetic dry wipe back panels.

- 52 x 30mm durable silver anodised aluminium frame.
- Vandal resistant 1.5 mm polycarbonate glazing panel.
- Magnetic pins included.
- Suitable for internal or external use with portrait orientation.
- Door stays fitted as standard on 4 x A4 model.
- Each menu case supplied with a set of keys.
- Glazing panels suitable for self adhesive vinyl or direct to surface print.
- Also available as a non-illuminated display (see page 94).

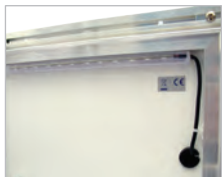

LED strip along top inside edge.



12V adaptor supplied with each unit.



3m waterproof extension cable available (page 181).



## Express made to order:

**Stock Colours:**  
Minimum order quantity 3

<b>Black</b> RAL 9005	<b>Sapphire Blue</b> RAL 5003	<b>Dusty Grey</b> RAL 7037	<b>Burgundy Red</b> RAL 3004
<b>Signal White</b> RAL 9003	<b>Moss Green</b> RAL 6005	<b>Traffic Red</b> RAL 3020	<b>Ultramarine Blue</b> RAL 5002



In stock



**Recyclable**  
Aluminium frames and polycarbonate glazing panels

## Available in 4 stock sizes

Size/Format	O/A Dimensions (w x h x d mm)	Header Size (mm)	Approx. Weight (kg)	Order Code
1 x A4	355 x 567 x 32	251 x 125	3.5	SKILLMC1XA4MK3
2 x A4 Vertical	355 x 884 x 32	251 x 125	5.5	SKILLMC2XA4VMK3
2 x A4 Horizontal	585 x 579 x 32	481 x 140	5.5	SKILLMC2XA4HMK3
4 x A4*	585 x 899 x 32	481 x 140	7.5	SKILLMC4XA4MK3

Also available in custom sizes (minimum order quantity 25).  
\* Door stays fitted as standard.

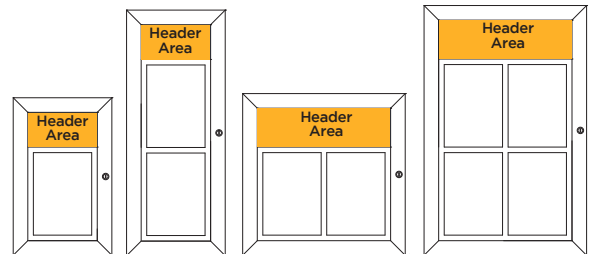

1 x A4

2 x A4  
Vertical

2 x A4  
Horizontal

4 x A4

# D-LIGHT

## Attractive convex lightbox for a range of poster sizes.

- A single sided display for internal wall mounting.
- Keyholes at rear for easy installation, suitable for portrait or landscape displays.
- Aluminium snapframe sides for quick and easy poster change.
- Silver finish steel case (RAL 9006).
- Acrylic opal diffuser panel ensures even light distribution.
- LED illumination gives low power consumption in use.
- 2m power cable, 12V power supply, wall fixings and CE certificate supplied with each unit.
- Custom sizes (minimum order quantity 50)\*.
- Custom colours (minimum order quantity 5).
- Maximum size 850 x 1250mm



'Pepper-pot' ventilation cover (all models). Units feature jack socket and on/off switch.



Option to use in landscape format – ideal for overhead and above-counter displays.



Custom sizes available (minimum order quantities apply).

Poster Size	Display Area (w x h mm)	O/A Dimensions (w x h x d mm)	Lighting	Weight (kg)	Availability	Order Code
A3	273 x 420	308 x 423 x 82	LED	3	In stock	DLIGHTA3LED
A2	395 x 594	424 x 597 x 98	LED	6		DLIGHTA2LED
20" x 30"	484 x 762	510 x 765 x 108	LED	7.5	Made to order	DLIGHT23LED
A1	570 x 841	592 x 844 x 120	LED	11.3	In stock	DLIGHTA1LED
30" x 40"	737 x 1016	750 x 1019 x 143	LED	15.5	Made to order	DLIGHT34LED
A0	816 x 1189	828 x 1192 x 150	LED	22		DLIGHTA0LED



**In stock**



**No tools assembly**



**Recyclable**  
Aluminium snapframe sides, steel case, acrylic diffuser panel and PET poster covers

# FREELIGHT PLUS

EU Design Registration No. 000433131

## The most cost-effective lightbox on the market.

Freelight Plus offers unbeatable **long-term return on investment** – simply change the insert for new promotions or leave in for permanent display.

- Uses existing in-store lighting for illumination.
- Flat-pack design – easy to assemble and install.
- Graphic inserts are quick and easy to update.

### Each kit includes:

- Outer lens panel.
- Opal 'lampshade' PVC insert- ideal for translucent vinyl or printed graphics.
- Pair of end caps.
- Ceiling hooks and 2 styles of 'button' eyelets.



Coloured and/or pad printed end caps available (minimum order quantity 500).

O/A Dimensions (w x h x d mm)	Weight (kg)	Order Code
648 x 256 x 226	1.3	FREELIGHTUNB



### Existing Lighting

Suspended ceilings offer prime advertising space and, with existing lighting, are perfect for Freelight Plus.

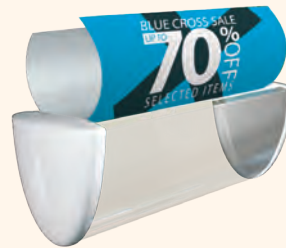

### Freelight Plus

With no need for wires or power, Freelight Plus is quick to assemble and simply hooks into place using the fixing kit supplied.



### High impact, low cost advertising

Most of the benefits of a traditional lightbox, but without the cost and inconvenience!

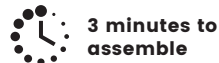

# ILLUMINATED TOTEM

## Double sided freestanding poster displays.

- For internal use only.
- Elegant convex design.
- Front opening snapframe sides for quick and easy poster change.
- Silver anodised aluminium casing with silver coated steel base.
- Anti-glare PET poster covers (permanently fixed on one vertical side with magnetic seal on the other).
- Fluorescent tube lighting (single or double depending on size).
- Supplied with 2m cable and plug.
- CE certificate supplied with each unit.



Easy opening snapframe sides.

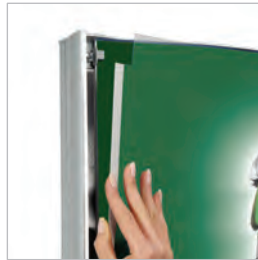

Quick poster change.



Openings concealed from view.

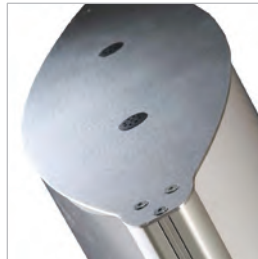

Ample ventilation to extend display life.



**In stock**

For 700 x 1700mm posters



**25 minutes to assemble**

Ideally by 2 people



**Recyclable**

Aluminium casing/snapframe sides, steel base, PET poster covers and acrylic diffuser

Poster Size (w x h mm)	O/A Dimensions (w x h x d mm)	Weight (kg)	Lighting	Availability	Order Code
600 x 1700	650 x 1720 x 350	28	1 x 58W	Made to order	IT6X17
700 x 1700	750 x 1720 x 350	30.8	1 x 58W	In stock	IT7X17
800 x 1700	850 x 1720 x 370	36.5	2 x 58W	Made to order	IT8X17





Get 1% for your community  
when you choose Co-op  
products and services

**co op** Membership

# Portable Exhibition Displays

- 
- **Curved Pop Up**
  - **Budget Roll-Up Banner**
  - **Rollsby**
  - **Quick Banner**
  - **X-Banner Stand**
  - **Promo Stands**
- 

**All our portable exhibition displays and roll-up banner stands are designed for one purpose – maximum impact at minimum cost.**

All designs are used to attract attention in a wide variety of event, promotion and retail situations, the range is chosen to be focused and functional.

You can buy the hardware only and then add your own graphics, or alternatively, use our print service with competitive prices to avoid hassle and cost.

**Curved Pop-Ups** create a large powerful backdrop, **Roll-Up Banners** prove popular for most situations, and there's a further range of display equipment to give a high visibility presence

# CURVED POP-UP

The ultimate exhibition accessory.

## Each kit includes:

- Collapsible aluminium frame (12mm diameter, silver finish) with black injection moulded fittings – sturdy, durable and long lasting.
- Set of magnetic bars and roll of magnetic 'B' tape.
- Roll of magnetic 'A' tape (for vertical panel edges).
- 2 x 150W clip-on spotlights with cable and plug.
- Semi-rigid trolley/case with built-in wheels and telescopic handle.
- Panels supplied with self adhesive 'headers' and 'kickers'. Headers secure panels at top, whilst kickers hold shape at bottom.

## Optional Printed Panels:

- 420 micron opaque white PVC.
- Supplied ready to fit with 'kick-strips' pre-applied.
- Available laminated (80 micron matt textured scratch resistant PVC).

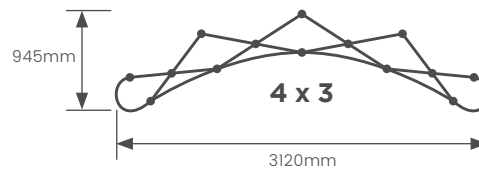
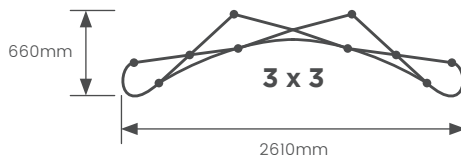

Size	Dimensions (w x h x d mm)	Option	Total Weight (kg)	Availability	Order Code
3 x 3	O/A: 2610 x 2320 x 660 Panel area: 3440 x 2300 Visual front: 2497 x 2300	Hardware kit	21	In stock	PUC3X3
		+ Printed panels*	27	Made to order	PUC3X3PVCDIGSOFT
		+ Lamination*	29	Made to order	PUC3X3PVCDIGSOFT-LAM
4 x 3	O/A: 3120 x 2320 x 945 Panel area: 4140 x 2300 Visual front: 3196 x 2300	Hardware kit	26	In stock	PUC3X4
		+ Printed panels*	33	Made to order	PUC3X4PVCDIGSOFT
		+ Lamination*	36	Made to order	PUC3X4PVCDIGSOFT-LAM

\* Please allow a 3-5 working day turn around (subject to quantity).



**In stock**



**10 minutes to assemble**  
By one person



**No tools assembly**



**Recyclable**  
Aluminium frame

# HARD TROLLEY CASE/COUNTER

## For Curved Pop-Ups.

- Sturdy yet lightweight moulded polyethylene case.
- Black polymer counter top - simply unfolds and clips into place.
- Built-in wheels for ease of movement.
- Stores all Curved Pop-Up components with space for optional graphic wrap.
- Optional graphic wrap kit includes magnetic fitting strips for quick and easy installation.
- Fitting strips are available for your own graphic wrap production.



Optional 'graphic wraps' feature magnetic strips for quick and easy installation.



Shown with 3 x 3 Curved Pop-Up.

Size	O/A Dimensions (w x h x d mm)	Weight (kg)	Colour	Order Code
Case	593 x 890 x 500	7	Black	MPUC
Counter Top	700 x 500 x 8	2	Black	MPUCTT
Graphic Wrap	1570 x 755 x 0.46	0.8	White	MPUCGW
Graphic fitting strips only	51 x 755 x 6	0.3	Silver	GWSTRIPS



**In stock**  
Graphic wraps made to order



**No tools  
assembly**



**Recyclable**  
Polyethylene case



# X-BANNER

Attract attention to showroom promotions with our sleek X-Banner Stands.

- Low cost, high impact banner display.
- Simple fold away design – no tools assembly.
- Displays 600 x 1600mm eyeleted banners in a wide range of materials (available made to order).
- Banners simply hook into place – quick and easy to remove and replace.
- Carbon fibre top poles provide excellent tension and stability, ensuring banners do not sag over time.
- Black canvas carry bag included (extra durable black carry case also available – see page 182).
- Lightblock PVC is recommended as banner choice.
- Option of 1000 x 2000mm display size available on request.

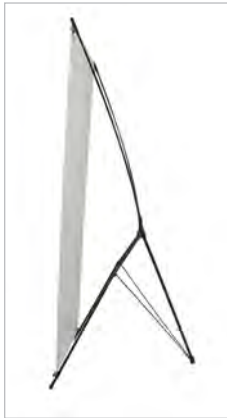

Side view.



Rear view.

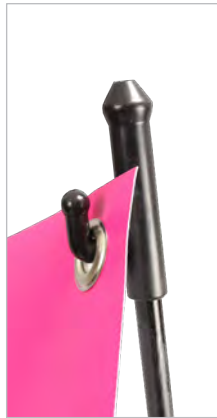

Simply hook banner material onto frame.

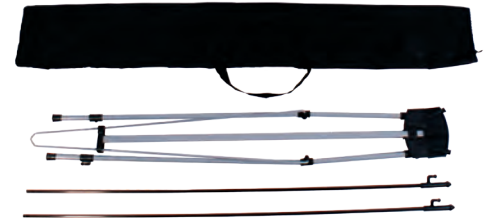

Black canvas carry bag included as standard.



**No tools  
assembly**



**In stock**



**1 minute to  
assemble**



**Recyclable**  
Steel legs and  
plastic mouldings

Banner Size (mm)	O/A Dimensions (w x h x d mm)	Weight (kg)	Order Code
600 x 1600	655 x 1690 x 690	2	XBAN600



# QUICK BANNER

## Discrete, compact and lightweight banner display.

- Top and bottom aluminium 'clamp rails' make installing and removing banners quick and easy.
- Double sided units with adjustable pole for final tensioning.
- Banner height (fixed): 2 metres.
- Available with digitally printed 'standard' 220 micron (0.22mm) rigid PVC or 'premium' 165 micron (0.165mm) polyester film banners.
- Lightweight carry bag included with each unit.
- Durable black carry cases also available separately (see page 182).



'Clamp rails' make installing and removing banners quick and easy.



### Double Sided

Banner Size (w x h mm)	Display Area (mm)	O/A Dimensions (w x h x d mm)	Weight (kg)	Availability	Order Code
600 x 2000	600 x 1970	606 x 2080 x 620	2.3	In Stock	QBD600
700 x 2000	700 x 1970	706 x 2080 x 620	2.7	Made to order	QBD700
800 x 2000	800 x 1970	806 x 2080 x 620	3	In Stock	QBD800
900 x 2000	900 x 1970	906 x 2080 x 620	3.4	Made to order	QBD900
1000 x 2000	1000 x 1970	1006 x 2080 x 620	3.8	In Stock	QBD1000



### Single Sided

Banner Size (w x h mm)	Display Area (mm)	O/A Dimensions (w x h x d mm)	Weight (kg)	Availability	Order Code
600 x 2000	600 x 1970	603 x 2060 x 413	1.5	In stock	QBS600
700 x 2000	700 x 1970	703 x 2060 x 413	1.75	Made to order	QBS700
800 x 2000	800 x 1970	803 x 2060 x 413	2	In stock	QBS800
900 x 2000	900 x 1970	903 x 2060 x 413	2.25	Made to order	QBS900
1000 x 2000	1000 x 1970	1003 x 2060 x 413	2.5	In stock	QBS1000



No tools assembly



Made to order



3 minutes to assemble



**Recyclable**  
Aluminium clamp rails, pole and stand



No tools assembly



Made to order



3 minutes to assemble



**Recyclable**  
Aluminium clamp rails, pole and stand

# BUDGET ROLL-UP BANNER

Low cost, lightweight and available in four stock sizes.

- Quick and easy to use.
- Soft round corners - no sharp edges.
- Available in 600, 800, 850 and 1000mm wide banners.
- Top 'clamp rail' and bottom adhesive strip makes banner installation and update a simple process.
- Silver anodised aluminium case with black fittings, top rail, pole and black centralised folding nylon foot and end caps.
- Complete with lightweight black carry case and full instructions.
- Available with digitally printed 'standard' 220 micron (0.22mm) rigid PVC or 'premium' 165 micron (0.165mm)\* polyester film banners.
- Available in cartons of 6 for the best possible price. Also available as individual units.

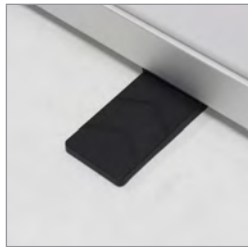

Banner Size (mm)	Display Area (mm)	O/A Dimensions (w x h x d mm)	Weight (kg)	Order Code (Single Unit)	Order Code (Pack of 6)
600 x 2035	600 x 2000	620 x 2090 x 260	1.30	RB600(1)	RB600(6)
800 x 2035	800 x 2000	820 x 2090 x 260	1.84	RB800(1)	RB800(6)
850 x 2035	850 x 2000	870 x 2090 x 260	1.88	RB850(1)	RB850(6)
1000 x 2035	1000 x 2000	1020 x 2090 x 260	2.15	RB1000(1)	RB1000(6)

\*Premium banners while stocks last.

 **No tools assembly**

 **In stock**

 **1 minute to assemble**  
+4 minutes if banner is not pre-loaded

 **Recyclable**  
Aluminium case, top rail and folding feet



# ECO ROLL-UP BANNER

Low cost, spring loaded 'roll-up' for single sided banners.

- Quick and easy to use.
- Soft round corners - no sharp edges.
- Available in 800mm and 850mm wide banners.
- Self-adhesive strips at top and bottom for easy banner installation.
- Silver anodised aluminium case, top rail, pole and folding feet.
- Complete with black padded carry case and full instructions.
- Available with digitally printed 'standard' 220 micron (0.22mm) rigid PVC or 'premium' 165 micron (0.165mm) polyester film banners.
- Hardware refined for the best flat & vertical banner presentation.



Adhesive top rail bonds to rear top edge of banner.



'Top-hat' pole/top rail connection.



Black padded carry case included with each unit.



**In stock**



**1 minute to assemble**  
+4 minutes if banner is not pre-loaded



**Recyclable**  
Aluminium case, top rail and folding feet



**No tools assembly**



Banner Size (mm)	Display Area (mm)	O/A Dimensions (w x h x d mm)	Weight (kg)	Order Code (Single Unit)	Order Code (Pack of 6)
800 x 2000	800 x 1985	820 x 2050 x 365	3	ERB800(1)	ERB800(6)
850 x 2000	850 x 1985	870 x 2050 x 365	3.1	ERB850(1)	ERB850(6)

**Please note:**

The Eco Roll-Up Banner is designed and built to a market-leading price and the savings derived from the use of lightweight materials and high speed assembly methods to achieve this can result in minor marks or irregularities in the product finish.

**Banner Materials:**

We recommend smooth surface, lightweight rigid roll materials for Eco Roll-Up Banners, such as 125 micron grey back polyester or 220 micron matt opaque PVC. Flexible, reinforced PVC banner materials have a textured surface and/or incorporate polymers which can react with adhesive tape so should be avoided. Do not use materials more than 300 micron thick.

## All round value roll-ups don't come any better than this.

- A useful promotional tool with little hardware costs.
- Single sided roll-up for interchangeable banners.
- Top 'clamp rail' and bottom Velcro strip makes banner installation and update a simple process.
- Two spare self-adhesive velcro strips supplied with each unit for future banner updates.
- Telescopic pole for 1550 – 1990mm height adjustment.
- Stylish silver anodised aluminium casing with black end caps and pole fittings – tough and hard wearing.
- Central stylised chrome foot.
- Premium padded carry case included with adjustable carry strap.
- Available with digitally printed 'standard' 220 micron rigid PVC or 'premium' 165 micron grey-backed polyester film banners.
- Premium banners prevent poster curl and are recommended for regular use.



Hard wearing/protective end caps.

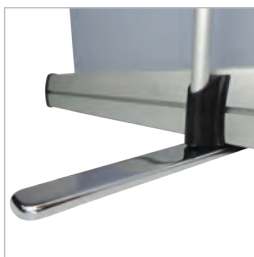

Stylish chrome foot.



Top clamp rail includes black push-fit end caps.



Premium padded carry case included with each unit, featuring separate pocket for pole and adjustable handle/shoulder strap.



**No tools assembly**



**In stock**



**1 minute to assemble**  
+4 minutes if banner is not pre-loaded



**Recyclable**  
Aluminium casing and pole

Banner Size (w x h mm)	Display Area (w x h mm)	O/A Dimensions (w x h x d mm)	Weight (kg)	Order Code (Single Unit)	Order Code (Pack of 6)
800 x 1760-2200	800 x 1550-1760	860 x 1700 - 2310 x 400	2.69	ROLL800(1)	ROLL800(6)
850 x 1760-2200	850 x 1550-1990	910 x 1700-2310 x 400	3.4	ROLL850(1)	ROLL850(6)



# PROMO STANDS

Lightweight, portable and cost-effective display counters, now available in 2 stock sizes.

- Flat-pack design – compacts for easy storage and transit.
- Moulded white High Impact Polystyrene (HIPS) counter top, base and shelf.
- White powder coated steel poles.
- White foam PVC header and polypropylene counter panel – ideal for printed vinyl application.
- Supplied complete with carry bag.



**No tools assembly**



**In stock**



**12 minutes to assemble**



**Recyclable**

Steel poles, moulded HIPS base, shelf and counter top, polypropylene counter panel and foam PVC header

## Petite Promo Stand:

Panel	Header	Counter
<b>Panel Size (mm)</b>	700 x 300	1596 x 900
<b>Display Area (mm)</b>	700 x 300	1584 x 824*
<b>O/A Dimensions (w x h x d mm)</b>	700 x 2150 x 390	
<b>Weight (kg)</b>	12.8	
<b>Maximum Shelf Weight</b>	Counter Top – 20kg Internal Shelf – 10kg	
<b>Order Code</b>	PETITPROMSTDWB	

\* Individual panel display areas –  
**Front:** 352 x 824 (x2). **Sides:** 340 x 824 (x2).

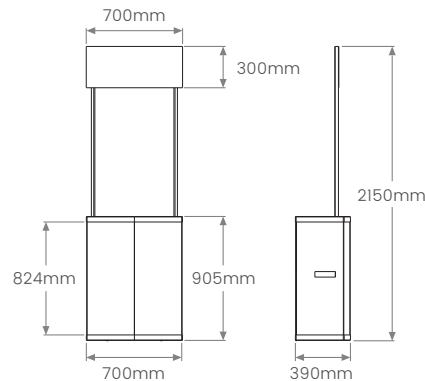

## Large Promo Stand:

Panel	Header	Counter
<b>Panel Size (mm)</b>	830 x 350	2004 x 900
<b>Display Area (mm)</b>	830 x 350	1976 x 810*
<b>O/A Dimensions (w x h x d mm)</b>	900 x 2200 x 510	
<b>Weight (kg)</b>	14.1	
<b>Maximum Shelf Weight</b>	Counter Top – 25kg Internal Shelf – 15kg	
<b>Order Code</b>	PROMSTDWB	

\* Individual panel display areas –  
**Front:** 444 x 810 (x2). **Sides:** 423 x 810 (x2).

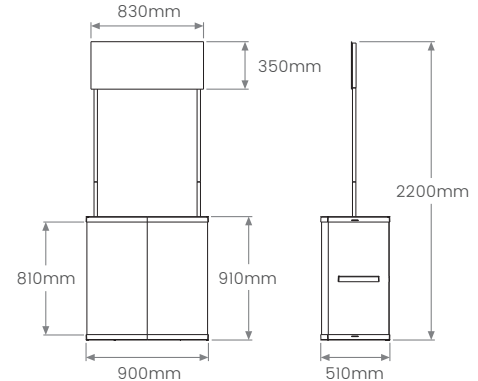

# PROMO COUNTERS

Highly visible Promo Counters available in convex or hexagonal shapes.

- Portable flat-pack design – quick and easy to assemble.
- Choice of two styles with white laminate or wood tops.
- Durable aluminium frames with silver anodised finish.
- White foam PVC display panels.
- Panels suitable for vinyl application or direct to surface print\*.
- Optional black carry bags available separately (see page 182).

\* Due to possible curvature in convex panels, caution is required when printing direct to surface with flatbed digital printers.



In stock



10 minutes to assemble



**Recyclable**  
Aluminium frames and  
foam PVC panels



## Convex Promo Counter:

O/A Dimensions (w x h x d mm)	Panel Sizes (w x h mm)	Weight (kg)	Top	Availability	Order Code
1060 x 930 x 580	Front: 980 x 878 (x1) Sides: 438 x 878 (x2)	18.1	White	In stock	CONVXW
		20.2	Wood	Made to order	CONVXWOOD

Maximum Loads – counter: 15kg / shelf: 6kg.



Convex back view  
with wood top.



Convex Promo Counter  
with white laminate top.

## Hexagonal Promo Counter:

O/A Dimensions (w x h x d mm)	Panel Sizes (w x h mm)	Weight (kg)	Top	Availability	Order Code
1225 x 930 x 550	Front: 659 x 878 (x1) Sides: 311 x 878 (x4)	19.3	White	Made to order	HEXAGW
		21.3	Wood		HEXAGWOOD

Maximum Loads – counter: 25kg / shelf: 10kg.



Hexagonal back view  
with wood top.



Hexagonal Promo Counter  
with white laminate top.



PROBABLY THE BEST INDIAN TAKEAWAY EAST OF NORWICH

# Acle Spice

INDIAN TAKEAWAY



## FREE HOME DELIVERY

ON ORDERS OVER £15 WITHIN A 4 MILE RADIUS  
(INCLUDING BLOFIELD, BRUNDALL, REEDHAM,  
UPTON, MARTHAM & LITTLE PLUMSTEAD &  
WINTERTON ON SEA)

01493 750800  
01493 751800

OPEN 7 DAYS A WEEK | 5PM - 11PM  
10% DISCOUNT (PRIVILEGE CARD  
HOLDERS PAYING CASH ON COLLECTION ONLY)

OLD BANK HOUSE,  
THE STREET, ACLE, NR13 3DY  
FREE PARKING AT THE BACK  
OF THE PREMISES - ALL MAJOR  
CREDIT CARDS ACCEPTED

SUMMER EDITION | MAY 2012

Order Online:  
[www.justeat.co.uk](http://www.justeat.co.uk)

**JUST  
EAT.CO  
.UK**



# Leaflet & Brochure Displays

- 
- **Decorative Brochure Stand**
  - **Zig-Zag Brochure Display**
  - **Interior Leaflet Holders**
  - **Exterior Leaflet Holders**
- 

This stylish and practical range of dispensers provides a solution for leaflet and brochure display in all locations.

Whether for car showroom, restaurant/takeaway or hotel/holidaylet, this range of **literature display** products will provide a means of displaying your marketing materials in a professional and easy to access manner.

**Spacemaster** can bring impact to any exhibition event or foyer display, whereas **Exterior Leaflet Holders** provide a 24/7 marketing presence wherever they are used.

# INTERIOR LEAFLET DISPENSERS

Crystal clear injection moulded styrene leaflet holders in a wide range of stock sizes.

- Great prices on mass produced lines – 1/3 A4, A5 and A4 single compartment dispensers.
- Colours and branding available on volume orders (minimum order quantities apply).
- Business card holders and other non-stock sizes available.
- Options for either freestanding or wall mounted situations.

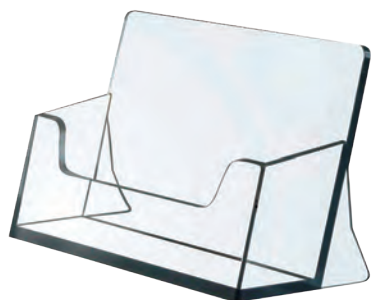

**Business Card Holder**

<b>O/A Dimensions (mm)</b>	95 x 55 x 39
<b>Order Code</b>	BUSCRDH



**In stock**



**No tools  
assembly**



**Fully  
Recyclable**





### Single Compartment

Description	1/3 A4 freestanding	A5 freestanding	A4 freestanding	1/3 A4 wall mounted	A5 wall mounted	A4 wall mounted
Opening Size (mm)	109 x 32	160 x 32	220 x 32	110 x 32	159 x 32	227 x 32
O/A Dimensions (mm)	113 x 198 x 83	164 x 198 x 83	224 x 291 x 96	114 x 165 x 40	163 x 165 x 40	231 x 249 x 40
Order Code	CT110BH	CT160BH	CT230BH	WH110BH	WH160BH	WH230BH

Single compartment leaflet dispensers available printed (minimum order quantity 200).

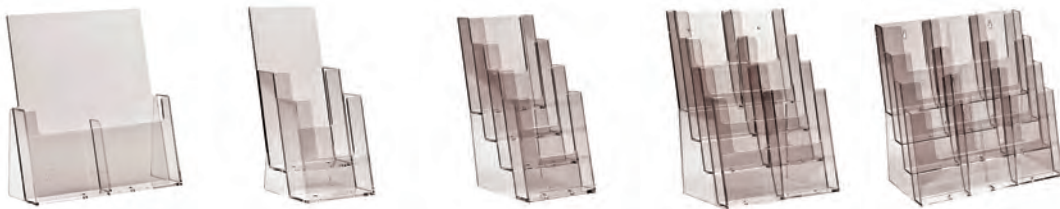

### Multi Compartment

Description	2 x 1/3 A4 side-by-side freestanding	2 x 1/3 A4 stacked freestanding	4 x 1/3 A4 stacked freestanding	4 x A4 stacked freestanding or wall *	4 x compartment A4 landscape stacked **
Opening Size (mm)	112 x 32 (x2)	110 x 42 (x2)	110 x 32 (x2)	230 x 32 (x4)	336 x 32 (x4)
O/A Dimensions (mm)	233 x 249 x 85	115 x 270 x 120	115 x 255 x 150	236 x 340 x 175	340 x 345 x 175
Order Code	BH2C112	BH2C110	BH4C110	BH4C230	BH4C330

Multi-compartment leaflet dispensers available printed (minimum order quantity 100).

\* Includes dividers for 8 x 1/3 A4 compartment option \*\* Includes dividers for a combination of compartment sizes, freestanding or wall mounted.

# EXTERIOR LEAFLET HOLDERS

Round-the-clock promotion, whatever the weather.

- Made from hard-wearing, crystal clear polystyrene with UV inhibitor for outdoor performance.
- Self closing acrylic lid ensures holder can never be left open and protects literature inside.
- Lid features integrated 'please take one' message.
- Ventilation holes on underside minimise condensation.
- Keyhole slots on rear for screw fixing to walls.



Self-closing acrylic lid with integrated 'please take one' message.



In stock



Fully Recyclable



Available in 3 stock sizes



1/3 A4 portrait (DL)



A5 portrait



A4 portrait

O/A Dimensions (mm)	127 x 227 x 40	178 x 227 x 45	248 x 323 x 55
Order Code	EXTLH1/3A4	EXTLHA5	EXTLHA4

## Simple and stylish literature displays.

- Designed to hold between 8 and 32 A4 brochures.
- Silver anodised aluminium frames (50 x 25mm) with acrylic brochure shelves.
- Single and double sided freestanding units available with optional wheels.
- Shelf internal capacity: 40mm (d).



Single sided wall mounted display for 8 x A4 brochures.



Double sided freestanding display for 16 x A4 brochures.



Single sided freestanding display for 16 x A4 brochures.

Single/Double Sided	Capacity	O/A Dimensions (w x h x d mm)	Weight (kg)	Availability	Order Code
Single (freestanding)	8 (4 x 2) x A4	546 x 1760 x 450	12.5	Made to order	BRCHSETFREE8
	12 (4 x 3) x A4	766 x 1760 x 450	15.9		BRCHSETFREE12
	16 (4 x 4) x A4	986 x 1760 x 450	19.4		BRCHSETFREE16
Single for wall	8 (4 x 2) x A4	520 x 1450 x 240	13	In stock	BRCHSETWALL8
	16 (4 x 2) x A4	546 x 1760 x 450	15.7		BRCHSETWALL16
Double (freestanding)	24 (4 x 3) x A4	766 x 1760 x 450	20.2	Made to order	BRCHSETDSFREE24
	32 (4 x 4) x A4	986 x 1760 x 450	25.7		BRCHSETDSFREE32



**Made to order**  
Single sided for wall mounting held in stock



**Fully Recyclable**

# WALL-MOUNTED LITERATURE DISPENSER

Space efficient display that keeps brochures and literature in easy reach.

- Wall mounted display for use in the office, classroom, shop or showroom.
- Three transparent A4 pockets provide high visibility for important information, sales literature and hand-outs.
- Secures to any flat wall surface with concealed fixings (included).
- Tough and robust with shatterproof PET-G dividers and recyclable PVC body.
- Supplied with plastic film cover sheets for protection in transit.



Grey



Black



White

O/A Dimensions (w x h x d mm)	Weight (kg)	Colour	Availability	Order Code
280 x 600 x 115	1.2	White	In stock	WMLD3XA4W
280 x 600 x 115	1.2	Black	Made to order	WMLD3XA4BLK
280 x 600 x 115	1.2	Grey	Made to order	WMLD3XA4GR



**In stock**  
White



**Fully Recyclable**

# DECORATIVE BROCHURE STAND

## Freestanding A4 brochure display plinth.

- A4 brochure display plinth, available in portrait or landscape.
- Clear 3mm polycarbonate display shelf for optimum strength (depth: 100mm).
- Header space provided for graphics if needed.
- Silver anodised aluminium stanchion (50 x 25mm oval).
- Moulded silver plastic base with hidden steel plate for stability.
- Supplied with screws, Allen key and plastic cover for protection in transit.



In stock



Fully Recyclable

Poster Size	Format	O/A Dimensions (w x h x d mm)	Weight (kg)	Order Code
A4	Landscape	970 x 250 x 330	3.5	DBSA4L
	Portrait	250 x 1000 x 330		DBSA4P



Display shelf assembly (Allen key supplied).

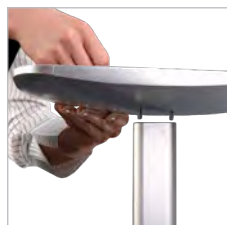

Base/leg assembly (Allen key supplied).

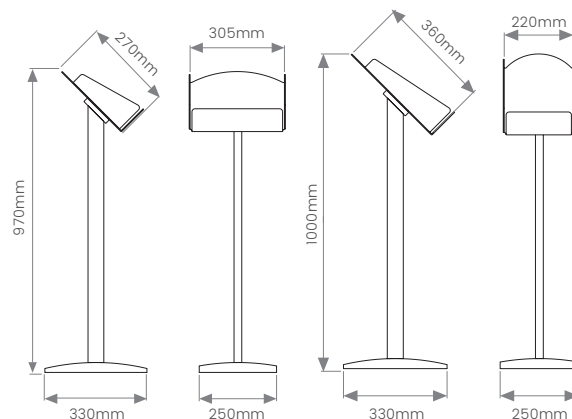



# SPACEMASTER

Freestanding brochure display with space saving cantilever design, ideal for presentations, exhibitions, conferences and events.

- Compact and easy to use.
- Supplied complete and ready to use – no assembly required.
- Base fascia suitable for permanent branding (e.g. vinyl graphics).
- Includes 5 x A4 high impact polystyrene brochure holders.
- Supplied complete with black padded carry bag.
- Literature can remain in place when folding down, although we suggest removal of top literature.

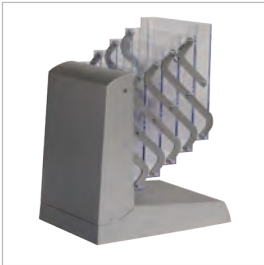

Compact and easy to store.



Hold base firmly and gently pull brochure holders upwards.



Hook levers to secure the brochure holders in place.

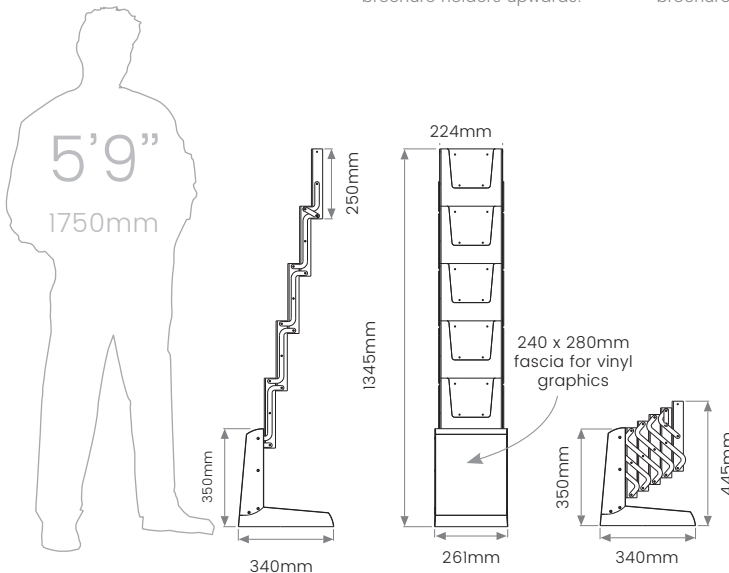

In stock



No tools  
assembly



Fully  
Recyclable

Base Fascia (w x h mm)	O/A Dimensions (w x h x d mm)	Weight (kg)	Order Code
250 x 280	Erect: 261 x 1345 x 340 Collapsed: 261 x 445 x 340	4.2	SPCEMSTRA4

# ZIG-ZAG BROCHURE DISPLAY

Eye-catching, premium brochure display with small footprint.

- 6 x A4 capacity with updateable convex header.
- 51 x 25mm flat oval aluminium legs and 10mm acrylic display shelves.
- Moulded silver plastic base with hidden steel plate for stability.
- Overall brochure stand footprint equals 300 x 420mm.
- Shelf dimensions: 220mm(w) x 42mm(d).



Double sided snapframe header – quick and easy to update.



218 x 165mm header insert protected behind cover sheet.



15 minute assembly time (Allen key supplied).

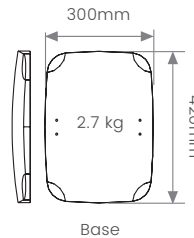
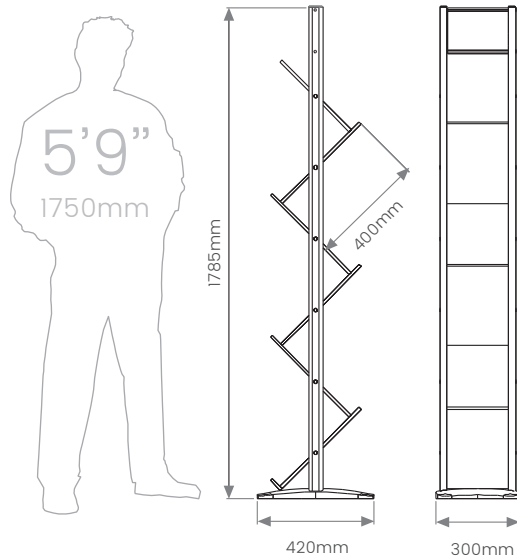

Made to order



15 minutes to assemble



Fully Recyclable

O/A Dimensions (w x h x d mm)	Weight (kg)	Order Code
300 x 1785 x 420	13.4	ZIG6XA4

# BROCHURE ISLAND STANDS

- Quick and easy to assemble with 'clip-fit' polystyrene brochure holders.

- Silver anodised aluminium frame.

**Diamond** With 10 x A4 brochure holders

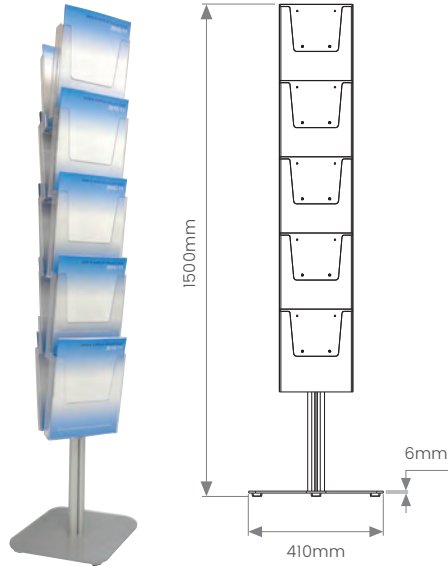

Easy base assembly.



Clip-fit brochure holders.

Capacity	O/A Dimensions (w x h x d mm)	Weight (kg)	Order Code
10 x A4	410 x 1500 x 330	11	MULTISIDEBODY(1)

\* 2 packs of MULTISHELF5XA4 required



**In stock**



**6 minutes to assemble**



**Fully Recyclable**

**Hexagonal** With 15 x A4 brochure holders

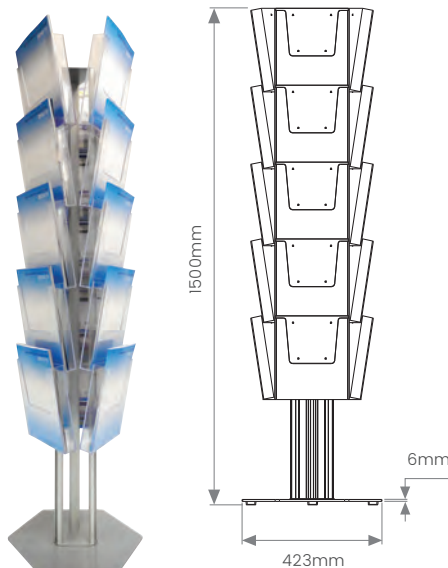

Easy base assembly.



Clip-fit brochure holders.

Capacity	O/A Dimensions (w x h x d mm)	Weight (kg)	Order Code
15 x A4	423 x 1500 x 370	16.2	MULTISIDEBODY(3)

\* 3 packs of MULTISHELF5XA4 required



**In stock**



**8 minutes to assemble**



**Fully Recyclable**

# Stylish 'walk-around' brochure display units.

**Small Oval** With 16 x A4 brochure holders

- Brochure holder internal depth: 35mm.

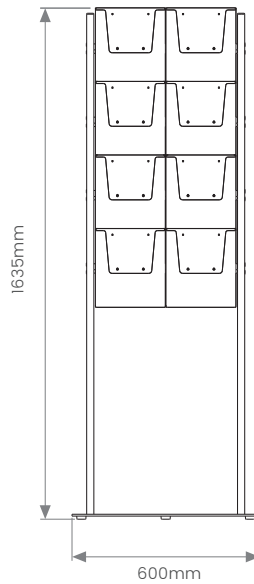

- Weighted steel bases for optimum stability.



Easy base assembly.

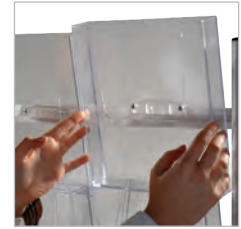

Clip-fit brochure holders.

Capacity	O/A Dimensions (w x h x d mm)	Weight (kg)	Order Code
16 x A4	600 x 1635 x 350	16.3	OVAL16XA4



Made to order



8 minutes to assemble



Fully Recyclable

**Large Oval** With 24 x A4 brochure holders

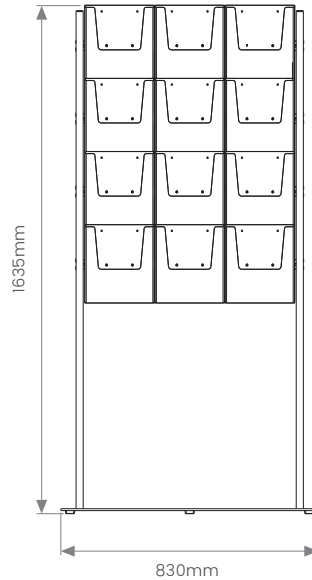

Easy base assembly.

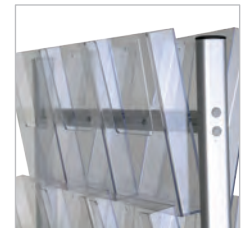

Clip-fit brochure holders.

Capacity	O/A Dimensions (w x h x d mm)	Weight (kg)	Order Code
24 x A4	830 x 1635 x 350	22.4	OVAL24XA4



Made to order



10 minutes to assemble



Fully Recyclable





# Menu & Information Displays

- 
- **Portland Menustand**
  - **Decorative Menuboard**
  - **Grip Talkers**
  - **Straight Talkers**
  - **Overture Menu Holder**
  - **Tilt Talkers**
- 

A functional range of smaller format poster, menu and information displays for wall, table/counter and floor mounting.

Included are holders manufactured in virtually unbreakable materials for demanding social environments.

All products are in stock and bulk manufactured to deliver low cost benefits.

Perfect for retail and hospitality sectors.

Many products offer the option to be used in landscape or portrait configuration.

# GRIP TALKERS

Simple yet stylish menu holders featuring our spring powered Grip Action Bases.

## PET Sleeves

- For double sided paper inserts.
- Semi rigid, hardwearing PET, perfect for busy pub and restaurant environments.
- Available in 1/3 A4, A5 and A4 stock sizes.

## Bases

- Aluminium with silver anodised finish as standard.
- Spring powered 'grip action' - simply open by hand, insert panel and release.
- Suitable for self adhesive vinyl, polydome stickers or pad printed graphics.
- Available in custom sizes, colours and finishes, made to order (minimum order quantity 100).
- Maximum pad-print height: 15mm. Minimum order quantity 50.

## Other Display Options

- These bases are suitable for almost any rigid sheet material between 1-4mm thick. E.g. acrylic, PVC, PET and foam PVC.
- Printed panels available made to order, minimum order quantity 25.



A4, A5 & 1/3 A4 in stock.



In stock



No tools  
assembly



Fully  
Recyclable



Simply grip the base open and insert the sleeve.



Spring powered 'grip action' bases clamp the insert.

Size	Base Dimensions (w x h x d mm)	O/A Height (mm)	Pack Quantity	Weight (kg)	Order Code
1/3 A4 (DL)	100 x 18 x 84	220	2	0.32	SWBASE1/3A4 + BHV100MH
			10	1.1	
A5	148 x 18 x 84	218	2	0.4	SWBASEA5 + BHV150MH
			10	1.6	
A4	210 x 18 x 84	313	2	0.6	SWBASEA4 + BHV210MH
			10	2.6	

# STRAIGHT/TILT TALKERS

## Crystal clear acrylic menu displays for double sided paper inserts.

- Made from hard wearing acrylic.
- For double sided message display.
- Presents and protects any paper inserts.
- Open edges for poster insert.
- Landscape made to order.

Size	O/A Dimensions (w x h x d mm)	Pack Options	Order Code
A6 Portrait	105 x 152 x 75	2 / 4 / 40	STRTA6P
1/3 A4 Portrait	105 x 212 x 75	2 / 4 / 40	STR1/3A4P
A5 Portrait	150 x 212 x 75	2 / 4 / 30	STRTA5P
A4 Portrait	210 x 302 x 105	2 / 4 / 40	STRTA4P

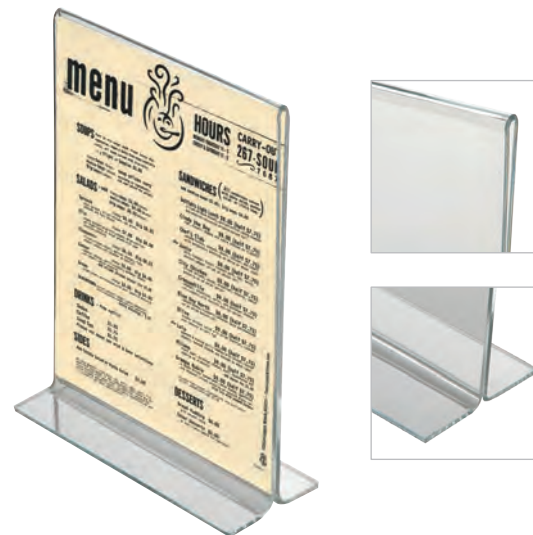

In stock



No tools  
assembly



Fully  
Recyclable

## Angled menu displays for single sided paper inserts.

- Angled design for optimum viewing from above.
- Made from hard wearing acrylic.
- Quick and easy to remove and replace inserts.
- For single sided message display.
- Presents and protects any paper insert.
- Landscape made to order.

Size	O/A Dimensions (w x h x d mm)	Pack Options	Order Code
A6 Portrait	105 x 155 x 72	2 / 5 / 30	TILTA6P
1/3 A4 Portrait	105 x 215 x 72	2 / 5 / 65	TILT1/3A4P
A5 Portrait	150 x 215 x 72	2 / 5 / 40	TILTA5P
A4 Portrait	210 x 305 x 92	2 / 5 / 40	TILTA4P
A4 Portrait with front pocket	210 x 305 x 120	1 / 10	TILTA4PFP



A4 portrait plus A7  
portrait pocket.



In stock



No tools  
assembly



Fully  
Recyclable

# OVERTURE MENU HOLDER

Crystal clear menu holders for double sided paper inserts.

- Made in injection moulded general purpose polystyrene (GPPS).
- Designed for style and strength.
- Oval bases with round edges, stylish and easy to clean.
- Finger cut out on top edge, making it quick and easy to change inserts.

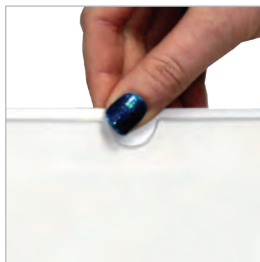

In stock



No tools  
assembly



Fully  
Recyclable

Available in 3  
stock sizes



**A6 Portrait**

Also suitable for 4" x 6"



**A5 Portrait**



**A4 Portrait**

O/A Dimensions (w x h x d mm)	124 x 157 x 65mm	170 x 215 x 70mm	232 x 303 x 90mm
Pack Options	2 / 4 / 25	2 / 4 / 25	2 / 4 / 25
Order Code	OVRTMHA6	OVRTMHA5	OVRTMHA4

# CLEAR MENU HOLDER

## Economical menu protection.

- Smooth, wipe clean PET sleeves and styrene bases.
- Transparent plinth for full visibility.
- Suitable for single or double sided paper inserts.
- Menu sleeve simply push fits in to base.
- Comes in packs of 2 or 10.
- Bases also available printed (minimum order quantity 100).



In stock



Fully  
Recyclable



No tools  
assembly



Available in 3  
stock sizes



1/3 A4 (DL)



A5



A4

O/A Dimensions (w x h x d mm)	100 x 220 x 50mm	152 x 238 x 63mm	212 x 330 x 86mm
Pack Options	2 / 10	2 / 10	2 / 10
Order Code	BHV100B + BHV100MH	BHV150B + BHV150MH	BHV210B + BHV210MH



# DECORATIVE MENUBOARD

## Freestanding internal poster display with front opening snapframe panel.

- Stylish internal poster display.
- Front opening snapframe for quick and easy poster change.
- Round corners for safety (mitred corners available made to order).
- Anti-glare PET poster cover ensures clarity when under spotlights.
- Polystyrene base with hidden steel plate for optimum stability.
- Silver anodised aluminium leg (50 x 25mm oval).
- Available in A4 and A3 stock sizes.
- Max. poster insert – 0.8mm thickness.

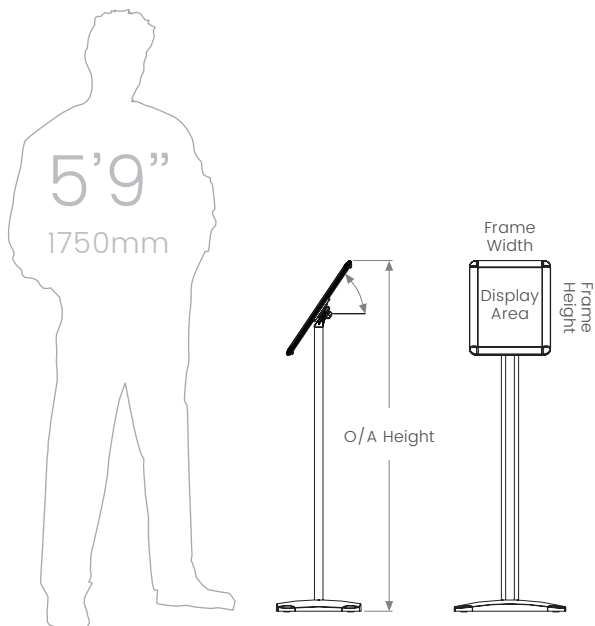

Landscape

Portrait

### 2 Displays in 1

Simply undo thumb screw at rear and rotate to landscape or portrait



Landscape



Portrait

Size	Dimensions (mm)	Display Area (mm)	Weight (kg)	Order Code
A4	O/A height: 1000 Frame: 240 x 327 Base: 250 x 330	279 x 192	3.5	DMBA4LP
A3	O/A height: 1200 Frame: 327 x 450 Base: 300 x 420	402 x 279	6.7	DMBA3LP



In stock



5 minutes to assemble



#### Recyclable

Aluminium frame, polystyrene back panel, PET poster cover, aluminium leg, polystyrene (HIPS) base and steel base plate

# PORTLAND MENUSTAND

Easy to convert between portrait and landscape, this highly versatile poster display is ideal for a huge range of applications.

- Telescopic pole for easily adjustable height.
- Simple 'clip and slide' mechanism for height adjustment.
- Quick and easy to change between portrait and landscape.
- Front opening snapframes for quick and easy poster change.
- Soft round corners for safety.
- All adjustments made by hand, no tools required.
- Anti-glare PET poster cover sheets ensure clarity of message.
- Base features hidden steel plate for optimum stability.
- Available in A4 and A3 stock sizes.



Quick and easy to change between portrait and landscape format.



Easily adjustable height – simply unclip and slide pole up/down.



Portrait format



Landscape format



**In stock**



**3 minutes to assemble**



**Recyclable**

Aluminium frame, PET poster cover, aluminium stand and steel base plate

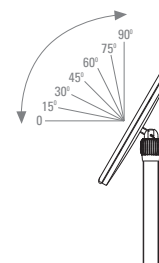
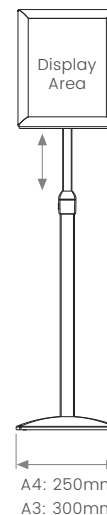
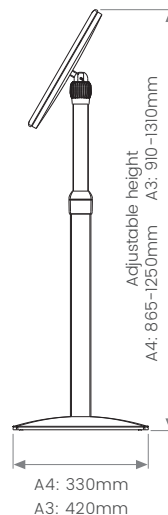

Size	Format	Dimensions (w x h mm)	Display Area (mm)	Weight (kg)	Order Code
A4	Landscape	330 x 865-1205	190 x 277	5.2	FLEXIMENUBOARDA4
	Portrait	250 x 910-1250			
A3	Landscape	420 x 910-1250	277 x 400	6.8	FLEXIMENUBOARDA3
	Portrait	300 x 970-1310			

# HI-LIGHT MENU STAND

## Freestanding LED display for A3 posters.

- LED halo effect 'edgelit' illumination for maximum 24/7 visibility.
- Quick and easy to switch between portrait and landscape – 2 in 1!
- Satin black powder coated pole and base with matching poster border.
- Ideal for 'meet and greet', menus, showrooms, galleries and museums.
- 3m power lead supplied (optional 3m extension cable available – see page 181).

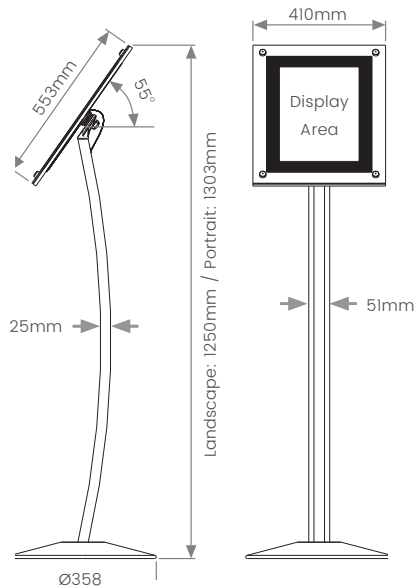

Portrait

### Simple assembly method:

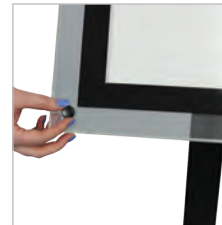

Screws on frame give access to change posters.



Power connector at bottom of pole.

Display Area (mm)	O/A Dimensions (w x h x d mm)	Weight (kg)	Order Code
279 x 402	Portrait: 358 x 1303 x 358	7.2	HILGHTMSA3
	Landscape: 358 x 1250 x 358		



In stock



10 minutes to assemble

Recyclable  
Steel base and aluminium pole

# SLIMLOK MENU CASE

## Featuring a magnetic/dry wipe back panel and header area.

- 52 x 30mm profile durable silver anodised aluminium frame.
- Vandal resistant 1.5mm polycarbonate glazing panel.
- Magnetic pins included.
- Suitable for internal or external use, with portrait orientation.
- Door stays fitted as standard on 4 x A4 model.
- Each menu case supplied with a set of keys.
- Glazing panels suitable for self adhesive vinyl or direct to surface print.
- Back panel is ideal for vinyl application.

### Express made to order:

**Stock Colours:**  
Minimum order quantity 3

**Black**  
RAL 9005

**Signal White**  
RAL 9003

**Dusty Grey**  
RAL 7037

**Traffic Red**  
RAL 3020

**Burgundy Red**  
RAL 3004

**Ultramarine Blue**  
RAL 5002

**Sapphire Blue**  
RAL 5003

**Moss Green**  
RAL 6005



Door stays fitted as standard on 4 x A4 model.



Supplied with set of magnetic pins.



**In stock**



**Recyclable**  
Aluminium frames and polycarbonate glazing panels



Also available as an illuminated display (see page 111).

**Available in 4 stock sizes**

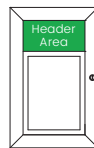

**1 x A4**



**2 x A4 Vertical**

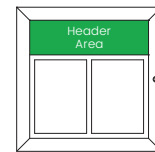

**2 x A4 Horizontal**

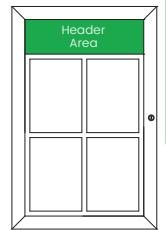

**4 x A4\***

Overall Dimensions (w x h x d mm)	355 x 567 x 32	355 x 884 x 32	585 x 579 x 32	585 x 899 x 32
Header Size (mm)	251 x 125	251 x 125	481 x 140	481 x 140
Approx. Weight (kg)	3	5	5	7
Order Code	SKMC1XA4MK3	SKMC2XA4VERTMK3	SKMC2XA4HORIMK3	SKMC4XA4MK3

Also available in custom sizes (minimum order quantity 5). \* Door stays fitted as standard.



ROYAL CANIN

Join the *Breeder Club* TODAY!

- Preferential prices
- FREE delivery on orders over 20kg
- FREE kitten recommendation packs
- Loyalty points scheme and exclusive promotions
- Dedicated breeder team and technical helpline
- Access to Breeder Management System

Ask for more details

For more information on the Royal Canin Breeder Club or to join call us on 0845 300 5965 or visit [royalcanin.co.uk](http://royalcanin.co.uk)



# Modular Pole Displays

- 
- **Poster Frames**
  - **Brochure Shelves**
  - **Brochure Holders**
  - **Slide-In Frames**
  - **Banner Set**
- 

This flexible low cost display system, designed for internal use, offers a multitude of options and applications.

The system supports combinations of poster, brochure and banner display elements, which means it is easily adaptable to suit a variety of needs.

Perfectly suited to retail, education and leisure locations.

# MODULAR POLE DISPLAY

Low cost free standing display system for posters, brochures & banners.

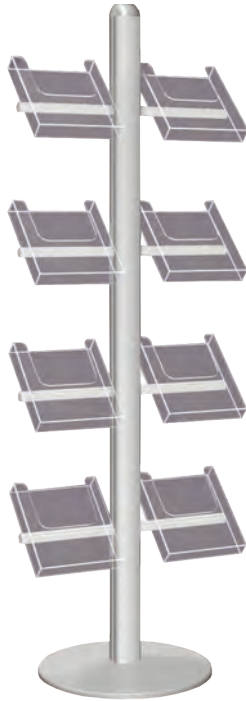

Holders with side mounting arms.



2-channel pole with Slide-In Frames and Banner Set.



2-channel pole with Poster Frames (round corners) and steel Brochure Shelves.



2-channel pole with 4 x steel Brochure Shelves.

- Ideal for internal/temporary sheltered outdoor use.
- Range of standard display options available.

- All components sold separately, so vast amount of custom configuration is possible from this versatile display system.



2-channel pole with 2 x 600mm wide Banner Set.



4-channel pole with Slide-in Frames and steel Brochure Shelf.



4-channel pole with Slide-in Frames.

# STANDARD COMPONENTS FOR MODULAR POLE DISPLAY

## Pole and Base.

- 70 x 70mm silver anodised aluminium poles.
- Silver powder coated steel bases.

### 2-channel pole with circular base and domed end cap

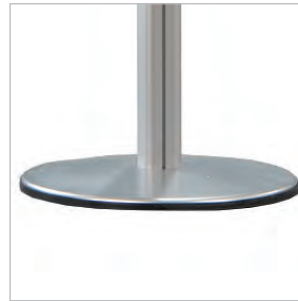

### 4-channel pole with square base and pyramid end cap

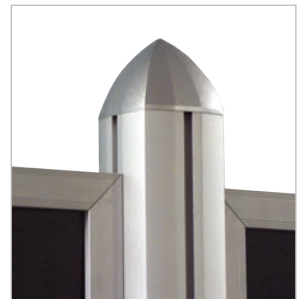
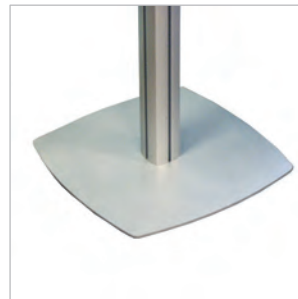

Pole Type	Base Dimensions (mm)	O/A Height (mm)	Weight (kg) inc. base	Order Code
2-channel	450 (diameter) x 35	1920	12.4	BP2
4-channel	450 x 35 x 450	1920	12.4	BP4



In stock



**Recyclable**  
Aluminium poles  
and steel bases

# STANDARD COMPONENTS FOR MODULAR POLE DISPLAY

## Poster Frames.

- Front opening aluminium snapframes for quick and easy poster change.
- 30mm profile, with a choice of round or mitred corners.
- Option to use in portrait or landscape format.
- Supplied with pre-fitted channel slide/clamps.



Slide-in assembly.

Corners	Poster Size	Weight (kg)	Availability	Order Code
Round	A2	1.7	In stock	BPFRAMEA2
Round	500 x 700mm	2	Made to order	PFR500700SA
Round	A1	2.8	In stock	BPFRAMEA1
Round	700 x 1000mm	3.5	Made to order	PFR7001000SA
Mitred	A2	1.7	Made to order	PFA2SA
Mitred	500 x 700mm	2	Made to order	PF500700SA
Mitred	A1	2.8	Made to order	PFA1SA
Mitred	700 x 1000mm	3.5	Made to order	PF7001000SA



4-channel pole with Poster Frame (round corners) and side-mounted Brochure Holders.

4-channel pole with A1 Poster Frame (round corners).



**In stock**  
A2 and A1 with round corners



**Recyclable**  
Aluminium snapframes and PET poster covers



# STANDARD COMPONENTS FOR MODULAR POLE DISPLAY

## Brochure Shelves.

- 2 x A4 portrait/1 x A3 landscape angled shelves.
- Available in silver powder coated steel or clear acrylic.



Steel

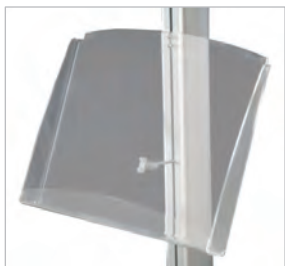

Acrylic



2-channel pole with 4 x steel Brochure Shelves.

## Slide-in Frames.

- Silver anodised aluminium frames with open top end.
- Clear PET poster cover sheets.
- Black polystyrene inner sheet included to provide light block between posters.



2-channel pole with 4 x A2 Slide-In Frames.

Material	O/A Dimensions (w x h x d mm)	Weight (kg)	Availability	Order Code
Steel	460 x 310 x 40	1.8	In stock	BPSTEELSHELF
Acrylic	460 x 310 x 40	1.4	Made to order	BPACRYLICSHelf



**In stock**  
Steel brochure shelves



**Recyclable**  
Steel/acrylic shelves

Poster Size	O/A Dimensions (w x h mm)	Weight (kg)	Order Code
A4 Portrait	233 x 320	0.83	BPSLIFA4
A3 Portrait	320 x 443	1.2	BPSLIFA3
A2 Portrait	443 x 617	1.82	BPSLIFA2



**In stock**



**Recyclable**  
Aluminium frame, PET poster cover sheets and polystyrene inner sheet

## Banner Set (Poster Hangers).

- Supporting arms simply slide into pole and can clamp in place at any height.
- Aluminium 'Poster Hanger' rails top and bottom, suitable for paper or banners up to 1mm thick.
- Concealed banner suspension.



2-channel pole with 2 x 600mm Banner Set shown.

Banner Height (mm)	Banner Width (mm)	Weight (kg)	Order Code
Up to 1700	400	0.28	BPBANARM400
Up to 1700	500	0.34	BPBANARM500
Up to 1700	600	0.41	BPBANARM600



**In stock**



**Recyclable**  
Aluminium supporting arms and rails

## Brochure Holders.

- Made with crystal clear high impact polystyrene (HIPS).
- Options for direct pole mounting or side mounting.

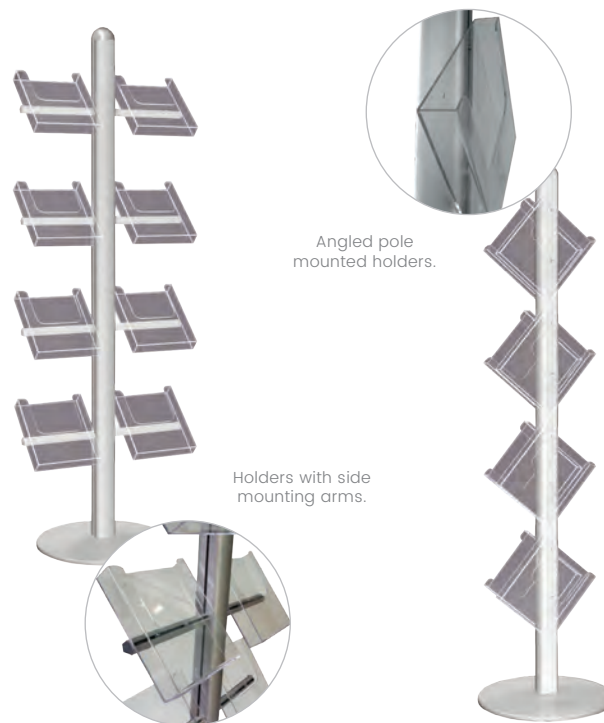

Angled pole mounted holders.

Holders with side mounting arms.

Type	Size	Weight (kg)	Availability	Order Code
With side mounting arm	A4	0.85	In stock	BPSIDESHelfA4
With side mounting arm	A5	0.55	In stock	BPSIDESHelfA5
With side mounting arm	1/3 A4	0.35	Made to order	BPSIDESHelf1/3A4
Angled for pole mounting	A4	0.45	In stock	BPANGBHA4



**In stock**



**Recyclable**  
High impact polystyrene (HIPS) brochure holders

**COSTA**

Try one of  
our delicious  
iced drinks!





# Chalkboards & Accessories

---

- **Chalk Insert Panels**
  - **Grip Chalkers**
  - **Counter/Table Top Chalkboards**
- 

This range includes everything from wall-mounted **Slatted Boards** to **Counter and Table-Top Boards**.

Combined with the modern benefits of liquid **Chalk Pens**, Chalkboards offer traditional marketing charm with instant message change flexibility, making them perfect for menus and short term promotions in pubs, restaurants, cafes and other hospitality venues.

# HIGH PRESSURE LAMINATE (HPL) CHALKBOARDS

## ABOUT HPL

Our remarkable High Pressure Laminate (HPL) chalkboards are capable of almost limitless use and application.

- Stays looking new for longer and never needs re-painting.
- Easy to clean with water and household cleaner.
- Weather and scratch resistant anti-glare surface.
- Suitable for use with traditional chalk and liquid chalk pens.
- Direct to surface screen and digital printing available.
- Available in a range of thicknesses: 2, 3, 4 and 6mm.

HPL's **hard wearing, maintenance free** properties make it ideal for both **internal and external use**. The specially formulated melamine surface means **your chalkboards stay looking new**.

## Custom made, wall mounted display.

- Available in 2, 3, 4 and 6mm thicknesses.
- Virtually any size and shape.
- Drilled ready for wall mounting.
- Available plain or printed, single or double sided.



### Made to order

Minimum order quantity 10 plain or printed.

## Waterproof chalkboard pens.

- Pens are rainproof after just 1 hour yet erasable with a damp cloth.
- Superior colour vibrancy and outdoor durability shown from our independent outdoor tests.
- Top tip... Mr Muscle 'window' is an excellent chalkpen cleaner.

Nib Size (mm)	Pack Quantity	Colour(s)	Order Code
5 (small)	5	Assorted *	CHALKPENSET1
15 (large)	3	White	CHALKPENSET2
15 (large)	5	Assorted *	CHALKPENSET3



\*Assorted pack contains: red, green, white, yellow and blue.



# CHALK INSERT PANELS

Turn any poster display into a chalkboard display, with these simple and inexpensive insert panels.

- High strength 500 micron black polypropylene (textured surface to front, smooth matte reverse).
- Suitable for use with liquid chalk pens.
- Suitable for screen/digitally printed graphics or vinyl application.
- Resistant to dirt and chemicals – stays looking new for longer.
- High temperature tolerance – long life even in outdoor use.
- Available in 3 stock sizes: A2, 20" x 30" and A1.
- Other sizes available made to order (up to 650 x 1100mm, minimum order quantity of 25).



**In stock**  
A2, 20" x 30" and A1



**Fully Recyclable**



A-Master with chalk insert panel fitted.



To view our range of **Chalk Pavement Signs and A-Boards**, see pages 4-32



1. Swinger Poster
2. Slimlok Poster
3. Modular Pole Display
4. Booster
5. Headlinerlite
6. Sightmaster 3
7. Snapframe

Poster Size	O/A Dimensions (mm)	Order Code
A2	420 x 594	INFA2CCB
20" x 30"	508 x 762	INF2030CCB
A1	594 x 841	INFA1CCB

# GRIPCHALKERS

Available in 2 stock sizes, these simple yet stylish table top chalkboards feature our spring powered Grip-Action Bases.

## HPL Chalkboard Panels

- 3mm High Pressure Laminate with round tops as standard.
- Suitable for traditional soft chalk and liquid chalk pens.
- Square top and custom shaped panels available made to order (minimum order quantity 25 and 50 respectively), with optional handle cut outs.
- Direct to surface printed panels available made to order (minimum order quantity 25).

## Bases

- Aluminium with silver anodised finish as standard.
- Spring powered grip-action – simply open by hand, insert panel and release.
- Suitable for self-adhesive vinyl, 'polydome stickers' or pad-printed graphics.
- Maximum pad-print height: 15mm. Minimum order quantity 50.
- Available in custom sizes, colours and finishes made to order (minimum order quantity 100).
- These bases are suitable for almost any rigid sheet material between 1-4mm thick. E.g. acrylic, PVC, PET and foam PVC.



Simply grip the base open and insert the chalkboard.



Spring powered 'grip-action' bases.



**In stock**



**No tools assembly**



**Recyclable**  
Aluminium bases

Bases available separately for your own sign panels – see Sign Holders on page 169.

Size	Base Dimensions (w x h x d mm)	O/A Height (mm)	Part	Display Area (mm)	Weight (kg)	Order Code
A5	148 x 18 x 84	222	Base only	–	0.8	SWBASEA5
			HPL panel	148 x 201	0.12	HPLTABLECHALKA5
A4	210 x 18 x 84	309	Base only	–	1	SWBASEA4
			HPL panel	210 x 288	0.24	HPLTABLECHALKA4

# COUNTER/TABLE TOP CHALKBOARDS

Traditional, high quality chalkboards with hardwood bases.

- 3mm High Pressure Laminate chalkboard panels, suitable for vinyl application, traditional chalk and liquid chalk pens.
- Hardwood (ash) bases with dark oak stain.
- Supplied in pairs, fully assembled and ready to use.
- Square top and custom shaped panels available made to order (minimum order quantity 25 and 50 respectively) with optional handle cut outs.
- Direct to surface printed panels available made to order (minimum order quantity 25).



**In stock**  
A5, A4 and A3



**No tools assembly**



Hardwood (ash) bases with dark oak stain.



A4 shown.

**Available in 3 stock sizes**



<b>Display Area</b> (mm)	148 x 200	210 x 287	297 x 410
<b>O/A Dimensions</b> (w x h x d mm)	148 x 221 x 69	210 x 308 x 69	297 x 431 x 69
<b>Weight</b> (kg)	0.7	1.1	2
<b>Order Code</b> (pack of 2)	CTCHALKA5	CTCHALKA4	CTCHALKA3

# SLATTED CHAIN BOARD

The Slatted Chain Board's unique design allows individual panels to be removed without interfering with the rest of the display.

- High Pressure Laminate chalkboard panels, suitable for traditional chalk or liquid chalk pens.
- 6 x 3mm (thick) slats, each with 500 x 83mm writing area.
- Available as reverse individual slats or whole board.
- Overall size: 550 x 935mm (header 210mm deep at centre).
- Header and footer panels allow for branding of the board.



Ideal for wall mounting.

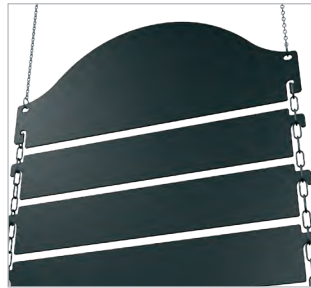

Also suitable for double sided display.



Individually reversible slats.



**Made to order**  
Minimum order quantity 10



**Recyclable**  
Steel chains

# SLATTED MAGNETIC BOARD

Remove and re-arrange magnetic strips in seconds.

- High Pressure Laminate chalkboard panels, suitable for traditional chalk or liquid chalk pens.
- 6 x 2mm (thick) slats, each with 500 x 85mm writing area.
- 3mm back panel provides header and footer space for additional message/branding, plus option to reverse for use as a single panel display.
- Overall size: 500 x 800mm.



Individual magnetic slats.



Reverse for single chalkboard display.



**Made to order**  
Minimum order quantity 10





MAGNUM<sup>®</sup>



MAGNUM<sup>®</sup>



# Sign Holders

---

- **Premier A-Board Frame**

- **Grip-Action Bases**

- **Pivot Grippers**

---

This range includes **Stand-Off Sign Fixings** that add prestige to any wall mounted sign. They assist mounting on to uneven surfaces, and ensure no visible dirt build-up behind a clear sign panel. Available from stock in two popular sizes and four finishes.

Another key product in this category is the **Premier A-Board Frame** - available by popular demand. Our two stock sizes allow you to make up A-Boards with a variety of sign panel materials simply and cost-effectively. It also has the benefit of our unique, hard wearing rubber hinges that set it apart from other A-Board designs.

# STAND-OFF SIGN FIXINGS

Add an architectural finish to any mounted sign panel.

As well as providing an attractive stand-off feature for any sign panel material, these fixings will accommodate any uneven wall surface. This could include any texture or render present on brick or stone walls.

Fixing sign panels forward from walls allows air to move freely across both the front and rear - eliminating condensation or any noticeable dirt build-up from behind. This is essential for clear sign materials (like glass or acrylic) so that the message is always visible.

Our fixings have no apparent screw heads, so this concealed mounting method acts as an effective tamper deterrent.

- Enhance the appearance of any sign panel.
- Hold sign panel thicknesses from 2mm to 12mm.
- Supplied in pairs in protective polythene enclosures.
- Screws and wall plugs are not included (since no two surfaces are ever the same, fixings should be selected to suit).
- Use 321 grade Stainless Steel stand-offs for long life in all external locations.



In stock



Fully  
Recyclable



**Protectively packaged  
in pairs**



**Stainless Steel**  
(321 grade, brushed)



**Aluminium**  
(Satin Silver)



**Aluminium**  
(Chrome Plated)



**Brass**  
(Plated Gold)

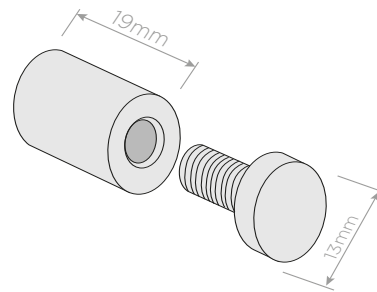
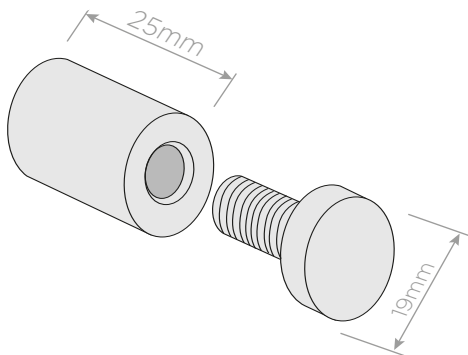

# STAND-OFF SIGN FIXINGS GUIDANCE

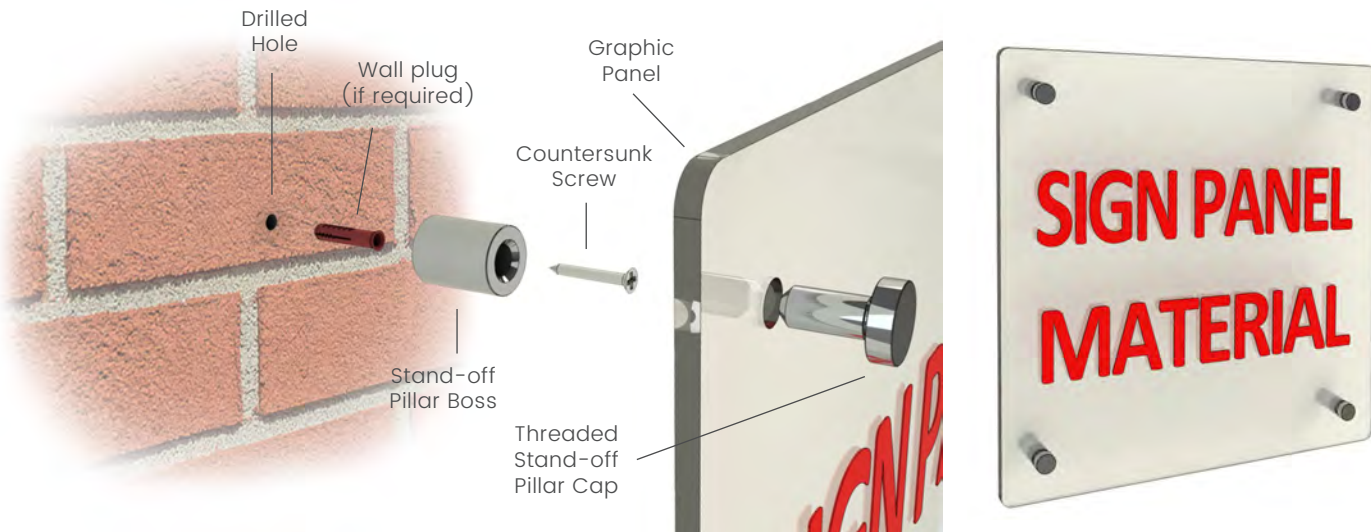

### Screw Selection Guide

Stand-off Pillar Size	Max. Screw Head Dia.	Max. Screw Thread Dia.	Hole Size in Sign Panel
13mm dia.	6.6mm	No. 6 (3.5mm)	8mm Required
19mm dia.	8.0mm	No. 8 (4.2mm)	10mm Required

## 13mm diameter

Item	O/A Dimensions (Dia x Stand-off height mm)	Panel Thickness Range (mm)	Order Code
<b>Stainless Steel</b> Self Colour	13 x 19	2 – 10	13X19SSSC
<b>Aluminium</b> Satin Silver	13 x 19	2 – 10	13X19ALSS
<b>Aluminium</b> Chrome Plated	13 x 19	2 – 10	13X19ALCP
<b>Brass</b> Plated Gold	13 x 19	2 – 10	13X19BRPG

## 19mm diameter

Item	O/A Dimensions (Dia x Stand-off height mm)	Panel Thickness Range (mm)	Order Code
<b>Stainless Steel</b> Self Colour	19 x 25	2 – 12	19X25SSSC
<b>Aluminium</b> Satin Silver	19 x 25	2 – 12	19X25ALSS
<b>Aluminium</b> Chrome Plated	19 x 25	2 – 12	19X25ALCP
<b>Brass</b> Plated Gold	19 x 25	2 – 12	19X25BRPG



# PREMIER A-BOARD FRAME

Take the leg work out of sign making.

- These frames offer excellent outdoor life thanks to their all-steel construction with Satin Black polyester powder coat finish. They are available in two sizes (small and large).
- Fully assembled ready for your slide-in panels.
- Will accept various panel materials up to 3mm thick (for small frames), or 4mm thick (for large frames).
- The slide-in design means panels are reversible, offering twice as much promotional opportunity.
- Possible panel materials include: ACM, Foam PVC, Acrylic and HPL.
- Hardwearing rubber hinges also provide self-levelling benefit for stability on uneven surfaces and a comfortable hand hold when carrying.
- Other colours available made to order (minimum order quantity 25).

 **In stock**

 **No tools assembly**



Stylish locking side arm on both sides.



Hardwearing rubber hinges.



Simple slide-in panel design.



Other colours available made to order (min. order quantity 25).

## Your panel dimensions

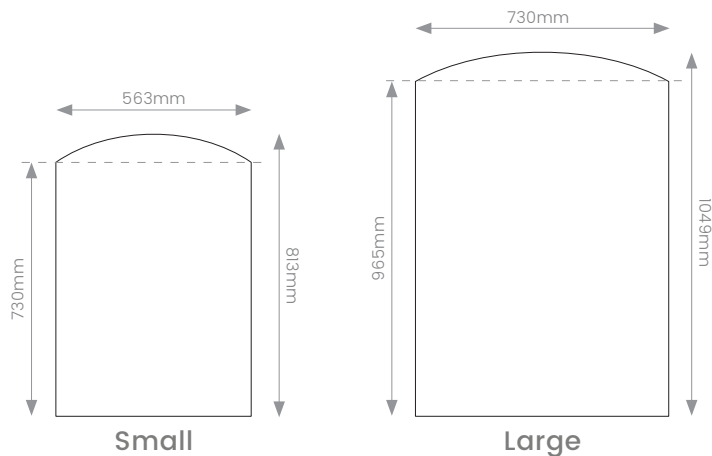

Size	O/A Dimensions (w x h x d mm)	Weight (kg)	Colour	Order Code
Small (3mm thick)	645 x 840 x 670	8.1	Black	METALFRAMEASSYSMCH
Large (4mm thick)	810 x 1110 x 690	10.3	Black	METALFRAMEASSYLGRCH

# GRIP-ACTION BASES

Spring powered bases – open by hand, insert panel and release.

- Aluminium with silver anodised finish as standard.
- Spring powered grip action – simply open by hand, insert sleeve and release.
- Holds all materials up to 4mm thick.
- Suitable for self adhesive vinyl, polydome 3D stickers or pad printed graphics.
- Maximum pad print height 15mm. Minimum order quantity 50.
- Available in custom sizes, colours and finishes made to order (minimum order quantity 100).



Take a look at our **GripChalkers** (P.161) and **GripTalkers** (P.141) to see these bases in action.



Simply grip the base open and insert the sleeve



Spring powered grip action bases



**In stock**



**No tools assembly**



**Recyclable**  
Aluminium bases

Size	Finish	Base Dimensions (w x h x d mm)	Order Code
1/3 A4 (DL)	Silver anodised	100 x 18 x 84	SWBASE1/3A4
A5	Silver anodised	148 x 18 x 84	SWBASEA5
A4	Silver anodised	210 x 18 x 84	SWBASEA4

# PIVOT GRIPPERS

Showcard mounting – ideal for chillers, product displays, shelving gondolas and counters.

- Simply stick to any smooth surface, insert your promotional material and angle as desired.
- Clear polycarbonate design ensures nothing spoils the view of your showcard or product information.
- Accepts card and other sheet materials between 0.8 and 2mm thick.
- Strong 3M self adhesive mounting pad sticks reliably to varied smooth surfaces.
- Adjusts 190 degrees through 10 positions for the very best display angle.
- Why not order showcards and pivot grippers together? The complete solution!

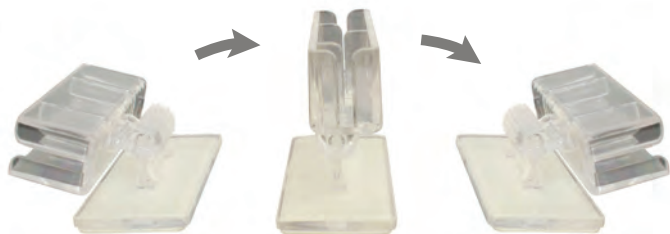

190 degree range of display angles.



**In stock**



**No tools  
assembly**

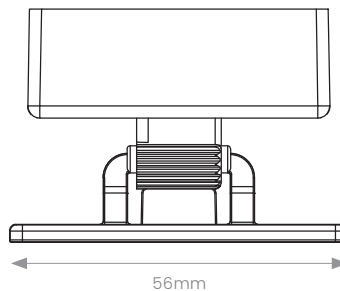

56mm

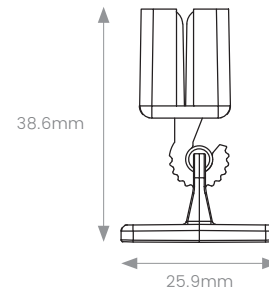

38.6mm

25.9mm

**SLUSH  
PUPPIE.**

**GET YOUR  
POWS ON  
ONE!**



**Regular**  
Regnlar



**Large**  
Large



# Print Services

---

• **Digital Printing**

• **Screen Printing**

• **Varnish Over-Print**

---

Our production facility offers a broad range of printing options. Including traditional screen, digital and dye sublimation processes.

We provide a range of timely, high-quality and cost-effective services using environmentally friendly materials. Our specialist staff can advise you on all your printing needs, from design to the finished product.

For more information on our printing services and capabilities, speak to our sales team.



## DIGITAL PRINTING

### The benefits of digital print:

- Prototypes and samples available.
- Allows for print onto unusual and uneven materials.
- High resolution looks great up close.
- Multiple/variable designs in a run.

Digital printing offers faster turn-around and lower cost than screen on smaller runs because set up times are minimal. Your digital artwork files once checked are 'ripped' to a state of the art flat-bed or roll-fed printers which print all colours in a single pass. Output definition and ink percentage are controlled depending on intended use or viewing distance.

It is very common to print a mixture of digital and screen processes to optimise the result and to produce the perfect reproduction of your artwork. Digital is added for full colour elements and screen to add spot Pantone colours and/or varnish.

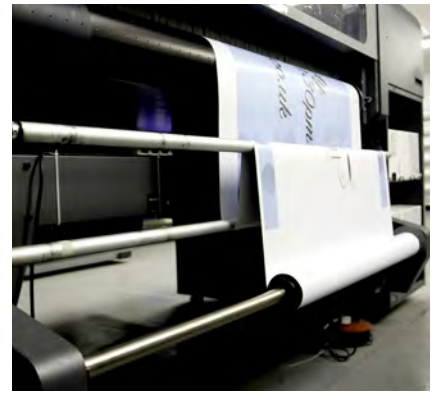

## SCREEN PRINTING

### The benefits of screen print:

- Precise Pantone or spot colour matching.
- Bold, vibrant colours and text due to thicker ink deposits.
- Simple spot or line colours.
- Extended outdoor life.
- Adding varnish to screen or digital print enriches colour, adds a gloss finish and increases protection.

The screen print process is very different to digital. Because each colour in the design has to be printed separately, a film stencil (screen) needs to be produced for each colour present in the design.



Dye sublimation is a method of printing that forces a layer of ink onto a surface via the use of heat. It is used widely and especially for textiles (soft signage) to produce flags, banners and retail/exhibition graphics.

### Benefits of dye sublimation:

- Is highly scuff resistant as a result of being 'fixed' into the media.
- On textiles produces graphics that can be washed and folded without fear of damage.
- On thinner fabrics it produces excellent show-through. Ideal for double sided flags.
- Dye sublimation can be applied via either digital or screen printing processes. However, quantities less than 100 are generally digitally printed.

## VARNISH OVER-PRINT

Although varnish is not essential, it is recommended for signage intended for outdoor use. As digital print is naturally matte, the finish is more inclined to attract dirt, this will ultimately dull the overall image. Adding a varnish over-print to your artwork will ensure for a brighter and more attractive external display.

### Benefits of varnish include:

- Enriched colour vibrancy and depth.
- Added protection from dirt and atmospheric pollution.
- Will help to repel dirt and keep the print looking brighter longer.
- Improved scuff and scratch resistance.
- Improved resistance to chemicals and solvents.



# PVC BANNER

High-impact printed display suitable for internal and external use.

- Available for the full range of popular banner sizes; from 1m x 1m up to 1m (wide) x 5m (long)
- Option of custom-sized banners up to a maximum size 3m (wide) x 20m (long)
- Choice of 3 different banner materials including a double-sided print capability
- Folded welded hems provide a 'double strength' perimeter for optimal wind load/tear resistance.
- Corrosion-free metal eyelets are fitted as standard for each PVC Banner
- Supplied with 300mm translucent white nylon cable ties- extremely secure, quick and easy to use to achieve the best banner appearance
- Individually poly-bagged, provides protection through storage and distribution

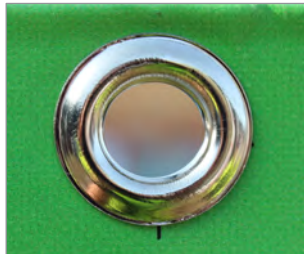

Gold finish metal eyelet.



All banners supplied complete with tie-wraps.



**Made to order**  
No minimum order quantity

## Front-Lit PVC 440gsm



Our most popular banner material for single sided print only. Front-Lit banners suit fence and wall-mounting locations.

## Light Block 440gsm



Our highest performing banner material, Light Block PVC provides excellent colour vibrancy and a long lasting performance. A light-block layer incorporated within the material prevents 'show-through'. Ideal for either single or double sided print.

## Mesh PVC 500gsm



Provides a semi-permeable surface to allow some air to pass through, making it well-suited for windy locations eg seafronts & site/event fencing. Full colour print is available on single side.





# ACCESSORIES & SPARES

Image	Product	Colour	Size (mm)	Order Code
	Swinger Aluminium Panels for vinyl or screen/digitally printed graphics	White	430 x 625 (Eco Swinger)	ECOPANWPAC
			500 x 750 (Swinger 2)	SWI2PWPAC
			588 x 917 (Swinger 3000)	SWI3PWPAC
			674 x 997 (Swinger 4000)	SW4KALIPANPAC
	Swinger Poster Pockets (top-opening) with printed border and magnetic closure (polycarbonate)	White border	281 x 404 (A3)	SWIECOPOSW
		Black border		SWIECOPOSB
		White border	500 x 750 (A2, Swinger 2)	SWING2PSTPACW
		Black border		SWING2PSTPACB
		White border	588 x 917 (20" x 30", Swinger 3000)	SW3KWPSTPAC
		Black border		SW3KBPSTPAC
		White border	674 x 997 (A1, Swinger 4000)	SW4KWPSTPAC
		Black border		SW4KBPSTPAC
	D-Flex Panel Hanger for Eco Swinger and Swinger 2 (pack of 2)	Black	21 x 60 x 42	ECOSWDFLEX3REPKIT
	D-Flex Panel Hanger for Swinger 2000, 3000 and 4000 (pack of 2)	Black	15 x 44 x 54	SWIDFLEX2REPKIT
	Tactical Header Clip for Swinger 3000, 4000 and Sentinel	Black	25 x 52 x 60	SWINGERCLIP01
	Tactical Header Clip for Eco Swinger, Swinger 2 and Sightmaster 3		46 x 48 x 35	SWINGERCLIP02
	Ecoflexlite Panel (Aluminium) for vinyl, digital or screen print	White	410 x 795	ECOFLITEPANPAC
	Ecoflex 2 Panel (Aluminium) for vinyl, digital or screen print	White	460 x 850	ECOFLEX2PANPAC
	Ecoflexextra Panel (Aluminium) for vinyl, digital or screen print	White	540 x 942	ECOFLEXTRAPANPAC
	Ecoflex 2 HPL Panel for chalk and liquid chalk pens. Can only be used in bases designed for 3mm thick panels	Black	460 x 850 x 3	ECOFLEX2HPLPAC
	Ecoflexextra HPL Panel for chalk and liquid chalk pens. Can only be used in bases designed for 3mm thick panels	Black	540 x 952 x 3	ECOFLEXTRAHPLPAC



Image	Product	Colour	Size (mm)	Order Code
	Self-Adhesive Magnetic Tape (A)	Brown	12mm x 30m	TAP0006
	Self-Adhesive Magnetic Tape (B)			TAP0043
	Self-Adhesive Steel Tape	White	12mm x 30m	TAP0007
	Poster Cover Sheets for Snapframes, A-Master and Sightmaster 2 and 3 (anti-glare 500 micron PET)	Clear	A2 poster	PET420594
			20" x 30" poster	PET508762
			A1 poster	PET594841
			30" x 40" poster	PET7621016
			A0 poster	PET8411189
			40" x 60" poster	PET10161524
	Poster Cover Sheets for Defender (anti-glare 500 micron PET)		30" x 40" poster	PET1035781
	Poster Cover Sheets for Cyclone 2 (gloss clear 700 micron PET)		40" x 60" poster	PET15461036
			40" x 60" poster	PET10161536700M
	Magnetic Poster Cover Sheets (anti-glare 500 micron PET with border) for Informer and Booster	White border	A2	INFA2CWPAC
		Black border		INFA2CBPAC
		White border	20" x 30"	INF2030CWPAC
		Black border		INF2030BLKPAC
		Silver/grey border		INF2030CSPAC
		White border	A1	INFA1CWPAC
		Black border		INFA1CBLKPAC
	Sentinel® Poster Cover Sheets (polycarbonate) with silver printed magnetic border, fixings and Allen key	Clear	30" x 40"	SEN34MK4PANEL
			A0	SENA0MK4PANEL
			40" x 60"	SEN46MK4PANEL
	Budget Banner Connectors (for Budget Roll Up Banner)	Black	-	RBDS
	Trolley	Silver	225 x 1220 x 225	TROLLEY
	Adaptor (req'd only for Sightmaster 2)	Silver	90 x 45 x 48	TROLLEYADAPTOR
	Hose	Yellow	5000 x 13	SENHOSE

Image	Product	Colour	Size (mm)	Order Code	
	Opening Tool for Security Snapframes	Grey	Length: 113	SFS0T01	
	Concrete Bases for Defender	Grey	600 diameter for 30" x 40" (53kg)	KIT01	
			800 diameter for 40" x 60" (80kg)	KIT02	
	Acrylic Brochure Shelves for Info Board	Clear	440 x 40 (single-sided, 2 x A4)	INFOSHLFSG	
			440 x 40 (double-sided, 4 x A4)	INFOSHLFDS	
	Magnetic Pins for Slimlok Noticeboard, Menu Case and Illuminated Menu Case (set of 8)	White	16 (h) x 12 (diameter)	MAGPINSETS	
	LED Power Supply for all single-sided Lightboxes and Menu Cases (12 volt/6 amp power rating)	Black	130 x 55 x 32	LEDPS1	
	Extension Cable for Slimlok Illuminated Menu Case and Edgelit XT	Black	3m	3000MM	
	HPL Chalkboard Panels for Premier Chalk A-Boards	Black	Small: 563 x 813 x 3	HPLPREMBOARDSM	
			Large: 730 x 1049 x 3	HPLPREMBOARDLG	
	Chalk Insert Panels Turn virtually any poster frame/holder into a chalkboard	Black	A2	INFA2CCB	
			20" x 30"	INF2030CCB	
			A1	INFA1CCB	
	Chalk Pens (see page 159 for full details)	Assorted	5 x 5mm nib (small)	CHALKPENSET1	
			White	3 x 15mm nib (large)	CHALKPENSET2
			Assorted	5 x 15mm nib (large)	CHALKPENSET3

Image	Product	Colour	Size (mm)	Order Code
	Grip-Action Bases for GripChalkers and GripTalkers	Silver	1/3 A4	SWBASE1/3A4
			A5 (148mm)	SWBASEA5
			A4 (210mm)	SWBASEA4
	Cross Base for Flying Banners	Grey	840 x 60	FBBASE(2)
	Water Bag for Flying Banners (use with Cross Base)	Grey	540 diameter	FBBAG(H)
	Ground Spike for Flying Banners	Silver	500	FBSPIKE(2)
	Wheel Base for Flying Banners	Black	480 x 35 x 520	FBWHEEL(2)
	Tank base with spindle	Black/Chrome	455 x 110 x 445	FBSMTK + TKBRG
	Tank base (second tank) for Flying Banners	Black	455 x 110 x 455	FBSMTK
	Spindle only	Chrome	58 x 237 x 58	TKBRG
	Concrete Base for Flying Banners (with bearing spindle)	Grey	600 (dia.) x 100 (h) (53kg)	FBCONC + FBCONCBRG
	Bearing Spindle	Black / Chrome	100 x 132 x 100	FBCONCBRG
	Hard Trolley Case/Counter for Curved Pop-Ups	Black	593 x 890 x 500	MPUC
	Counter top	Black	700 x 8 x 500	MPUCTT
	Graphic fitting strips only	Black	-	GWSTRIPS
	Carry Cases for Quick Banners (BCB10 also for X-Banner Stand)	Black	Banner width: up to 800	BCB8
			Banner width: up to 1000	BCB10
	Carry Bags for Promo Counters	Black	Convex (in stock)	CONVBG
			Hexagonal (made to order)	HEXAGBG

# RECOMMENDED POSTER MATERIALS

To ensure best performance against condensation/moisture ingress in outdoor poster advertising, we recommend:

## For 1–3 months life

### Wet strength, water resistant or waterproof paper (115–200gsm)

Additives included during paper manufacture prevent the paper from breaking apart when in contact with moisture, ensuring it remains strong and stable. These are common specifications for short to medium term poster campaigns and billboard advertising.

## For 3 months+ life

### Lamination

Encapsulating a paper poster in thin sheets of clear plastic. This is a common means of protecting posters for outdoor use when water-soluble inks are used. Delivers reliable performance if the encapsulation is made to seal around the whole perimeter of the poster.

### Printing onto plastic

Synthetic Paper (80 micron minimum thickness polypropylene), sometimes termed 'Poly Poster', or 220 micron PVC are cost effective alternatives for longer-life applications e.g. displaying a business service offer, restaurant menus or repeating seasonal promotions.

## Maximise your poster performance with our design tips

- Use font in lower case with 80mm+ height for fast recognition.
- Simple typefaces make message clearer – avoid serif typefaces and italics.
- Amplify images and messages by using outline silhouette and drop shadow effects.
- Reduce heat absorption (solar gain) on outdoor poster signs by limiting regions of dark colour print.

## Paper Sizes

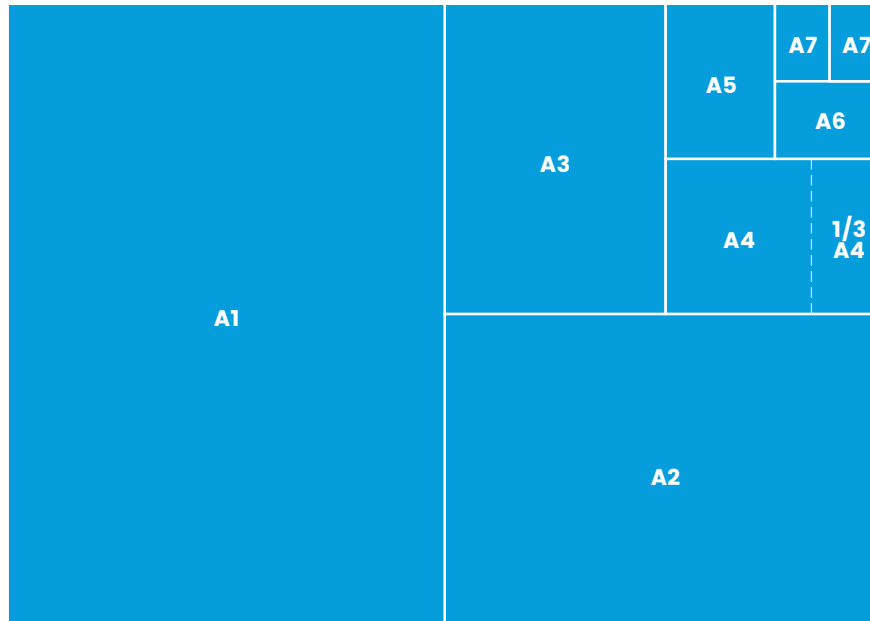

## Conversion Table

Size	Millimetres	Inches
A7	74mm x 105mm	2 7/8" x 4 1/8"
1/3 A4	99mm x 210mm	8" x 4 1/4"
A6	105mm x 148mm	4 1/8" x 5 7/8"
A5	148mm x 210mm	5 7/8" x 8 1/4"
A4	210mm x 297mm	8 1/4" x 11 3/4"
A3	297mm x 420mm	11 3/4" x 16 1/2"
A2	420mm x 594mm	16 1/2" x 23 3/8"
20" x 30"	508mm x 762mm	20" x 30"
A1	594mm x 841mm	23 3/8" x 33 1/8"
30" x 40"	762mm x 1016mm	30" x 40"
A0	841mm x 1189mm	33 1/8" x 46 3/4"
40" x 60"	1016mm x 1524mm	40" x 60"

## Description of Goods

Before using any of these products, the customer shall determine the suitability of the product for its intended use, and the customer assumes all risks and liability whatsoever in connection herewith. The supplier shall not be liable either in tort or in contract for any loss or damage – direct, incidental or consequential, arising out of the use of, or the inability to use any of the products.

All specifications, drawings, illustrations, particulars of weight and dimensions issued are approximate only and do not form part of any terms, conditions or warranties of any contract. The supplier may vary such specifications, drawings, illustrations, particulars of weight and dimensions at any time and for whatever reason, without having to give a reason or explanation.



## A

A Bit About Print .....	173
A-Board .....	24
A-Boards at a Glance .....	23
A-Master .....	25
A-Master Plus .....	26
Accessories and Spares .....	179
Adfresco Café Barrier .....	51
Adfresco Café Barrier Selection Tool .....	53

## B

Best Buy LEDbox .....	108
Bollard Wraps .....	46
Booster .....	28
Brochure Display Units .....	132
Brochure Island Stands .....	137
Budget A-Board .....	31
Budget Banner Connectors .....	122
Budget Roll-Up Banner .....	121

## C

Cable Suspended Snapframes .....	87
Café and Rope Barrier Systems .....	50
Chalk Insert Panels .....	160
Chalkboards & Accessories .....	158
Chalkstar .....	30
Clear Menu Holder .....	144
Counter/Table Top Chalkboards .....	162
Counterstand Snapframes .....	86
Curved Pop-Up .....	117
Custom Manufacturing Service for Snapframes .....	79
Custom Shaped Flange Signs .....	60
Custom Shaped Panels .....	18
Cyclone 2 .....	43

## D

D-Light .....	112
Decorative Brochure Stand .....	134
Decorative Menuboard .....	145
Defender .....	44

## E

Eco Roll-Up Banner .....	123
Eco Swinger Panel Option .....	7
Eco Swinger Poster Option .....	8
Ecoflex .....	17
Ecoflex 2 .....	20
Ecoflex 2 and Ecoflexextra Totem .....	22

Ecoflexlite .....	19
Ecoflexextra .....	21
Edgelit XT.....	110
Exterior Leaflet Holders .....	131

## F

Feather Flying Banner .....	67
Feature Floor Mat .....	178
Felt Showboard .....	94
Flange Signs .....	59
Flying Banner Selection Tool .....	65
Forecourt Signs .....	34
Frameworkz .....	88
Freelight Plus .....	113

## G

Giant Pole .....	74
Grip Talkers .....	141
Grip-Action Bases .....	171
Grip Chalkers .....	161

## H

Hard Trolley Case/Counter .....	118
Headliner .....	97
Headlinerlite .....	98
Hi-Light Menu Stand .....	147
Hi-Sight .....	95
High Pressure Laminate Chalkboards .....	159

## I

Icon Key .....	1
Illuminated Poster Frames, Noticeboards & Displays .....	106
Illuminated Slimlok Menu Case .....	111
Illuminated Totem .....	114
Info Board .....	103
Informer .....	27
Interior Leaflet Dispenser .....	129

## L

Leaflet & Brochure Displays .....	128
LED & Fluorescent Light Information .....	107
Lockable Snapframes .....	85

## M

Menu & Information Displays .....	140
Minimus Snapframe .....	83

Modular Pole Displays .....	150
Mounting Accessories for Flying Banners .....	71

## N

Non-Illuminated Poster Frames & Noticeboards .....	90
Noscrewz Flag .....	62

## O

Overture Menu Holder .....	143
----------------------------	-----

## P

Pavement Signs & A-Boards .....	4
Pivot Grippers .....	172
Pole & Rope Barrier .....	56
Portable Exhibition Displays .....	116
Portland Menustand .....	146
Poster Clamp .....	100
Poster Hanger .....	101
Poster Pillar .....	104
Poster Snap .....	99
POW! Sign .....	41
Premier A-Board Frame .....	170
Premier Chalk A-Board .....	29
Print Services .....	174
Projecting Signs & Flags .....	58
Promo Counters .....	126
Promo Stands .....	125
PVC Banner .....	177

## Q

Quick Banner .....	120
Quick Reference Guide for Adfresco and LT .....	55
Quick Reference Guide for Flags .....	64
Quick Reference Guide for Flying Banners .....	70
Quick Reference Guide for Forecourt Signs .....	48
Quick Reference Guide for Swinger and Ecoflex .....	16

## R

Recommended Poster Materials .....	183
Rectangular Flying Banner .....	69
Rollsby .....	124

## S

Security Snapframes .....	84
Sentinel .....	35
Sentinel Banner .....	37

Sightmaster 3 .....	39
Sign Covers .....	45
Sign Holders .....	166
Sign Nav .....	102
Slatted Chain Board .....	163
Slatted Magnetic Board .....	164
Slimlok Menu Case .....	92
Slimlok Noticeboard .....	93
Slimlok Poster Case .....	91
Snapframes .....	76
Spacemaster .....	135
Stand-Off Sign Fixings .....	167
Stand-Off Sign Fixing Guidance .....	169
Standard Components for Modular Pole Display .....	153
Standard Flag Kit .....	63
Standard Snapframes .....	79
Stock Finishes for Snapframes .....	78
Straight/Tilt Talkers .....	142
Sucker Flags .....	61
Swinger .....	5
Swinger 2 Panel Option .....	9
Swinger 2 Poster Option .....	10
Swinger 3000 Panel Option .....	11
Swinger 3000 Poster Option .....	12
Swinger 4000 Panel Option .....	13
Swinger 4000 Poster Option .....	14

## T

Tactical Header for Sightmaster 3 .....	40
Tactical Header for Sentinel .....	38
Tactical Header for Swingers .....	15
Teardrop Flying Banner .....	68
Trolley and Hose .....	47

## W

Wall-Mounted Literature Dispenser .....	133
Waterbase A-Board .....	32
Waterbase Pyramid .....	32
Weatherproof Smart LEDbox .....	109

## X

X-Banner .....	119
----------------	-----

## Z

Zig-Zag Brochure Display .....	136
--------------------------------	-----

